

端子台系列

为中大型智能装备制造企业提供一站式配电器材解决方案

Wenbuluo

2026 V.1.0

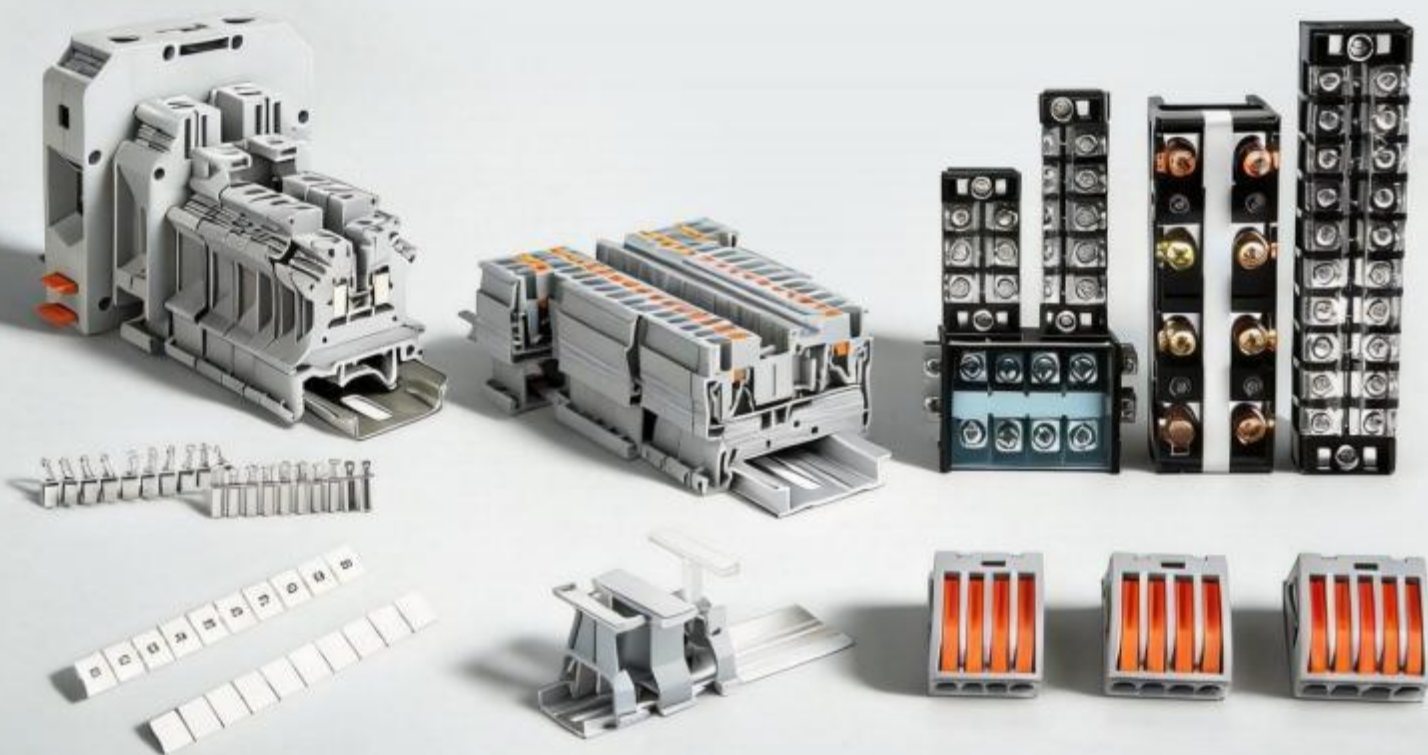



端子台系列



C-01
WUK系列欧式螺钉端子



C-02
WUK黄绿接地端子



C-03
WUK系列附件

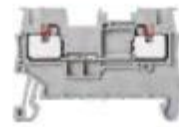

C-04
WD6直插式弹簧接线端子



C-05
WD5系列弹簧接线端子



C-06
WD5系列附件



C-07
MBK通用型小型接线端子



C-08
JF5系列组合式接线端子



C-09
TK系列接线端子



C-10
IN系列接线端子



C-11
TBR组合接线端子



C-12
TBD组合接线端子



C-13
小母线固定式接线端子



C-14
TB系列接线端子



C-15
TA系列接线端子



C-16
TBC系列接线端子



C-17
TD系列接线端子



C-18
TC系列大电流接线端子



C-19
短接片系列



C-20
TBC/TBR/TBD防尘盖板



C-21
快速接线端子



C-22
电度表接线端子



C-23
UKK单级分线端子

C-01 WUK螺钉接线端子



WUK1.5N



产品信息Product Information			
产品型号 Model	WUK1.5N		
尺寸Size	宽	高	厚
	42.5	41.5	4.2
产品材质 Material	外壳	压接件	螺钉
	尼龙	黄铜	M2
技术参数Technical data			
	IEC	UL	
额定电压 Rated voltage	500	300	
额定电流 Rated current	17.5	15	
接线容量 Wire Range	刚性 Solid	柔性 Fine Stranded	
平方数 mm ²	0.2-1.5	0.2-1.5	
AWG	30-14	30-14	
绝缘阻燃等级 Insulating Flammability Rating	UL94-V0		
颜色 Color	WUK1.5N Grey 常规 WUK1.5N Blue 定制		
附件产品 Accessories Product			
端板 Cover Plate		D-WUK1.5	
分组隔片 Partition Plate		ATP-WUK	
隔片 Separating Plate		TS-KK3	
中心联件 Jumper		FBI 10-4	
边插链接件 Plug-in Bridge		—	
标记条 Zack Marker Strip		ZB4 横/竖/空白	
标记夹/座 Mark Clip		UBE/D UK-B1 KLM-A	
终端固定件End Clamp		E/UK	

WUK2.5B



产品信息Product Information			
产品型号 Model	WUK2.5B		
尺寸Size	宽	高	厚
	42.5	41.5	6.2
产品材质 Material	外壳	压接件	螺钉
	尼龙	黄铜	M3
技术参数Technical data			
	IEC	UL	
额定电压 Rated voltage	690	600	
额定电流 Rated current	32	20	
接线容量 Wire Range	刚性 Solid	柔性 Fine Stranded	
平方数 mm ²	0.2-4	0.2-2.5	
AWG	30-12	30-12	
绝缘阻燃等级 Insulating Flammability Rating	UL94-V0		
颜色 Color	WUK2.5B Grey 常规 WUK2.5B Blue 定制		
附件产品 Accessories Product			
端板 Cover Plate		D-WUK2.5B	
分组隔片 Partition Plate		ATP-WUK	
隔片 Separating Plate		TS-KK3	
中心联件 Jumper		FBI 10-6/FBI 10-6N/EB2-6	
边插链接件 Plug-in Bridge		EB3-6/EB10-6	
标记条 Zack Marker Strip		ZB6 横/竖/空白	
标记夹/座 Mark Clip		UBE/D UK-B1 KLM-A	
终端固定件End Clamp		E/UK	

C-01WUK螺钉接线端子



WUK3N



产品信息Product Information			
产品型号 Model	WUK3N		
尺寸Size	宽	高	厚
	42.5	46	5.2
产品材质 Material	外壳	压接件	螺钉
	尼龙	黄铜	M3
技术参数Technical data			
	IEC	UL	
额定电压 Rated voltage	800	600	
额定电流 Rated current	32	20	
接线容量 Wire Range	刚性 Solid	柔性 Fine Stranded	
平方数 mm ²	0.2-4	0.2-2.5	
AWG	28-12	28-12	
绝缘阻燃等级 Insulating Flammability Rating	UL94-V0		
颜色 Color	WUK3N Grey 常规 WUK3N Blue 定制		
附件产品 Accessories Product			
端板 Cover Plate		D-WUK4/10	
分组隔片 Partition Plate		ATP-WUK	
隔片 Separating Plate		TS-K	
中心联件 Jumper		FBI 10-5/EB2-5	
边插链接件 Plug-in Bridge		EB3-5/EB10-5	
标记条 Zack Marker Strip		ZB5 横/竖/空白	
标记夹/座 Mark Clip		UBE/D UK-B1 KLM-A	
终端固定件End Clamp		E/UK	

WUK5N



产品信息Product Information			
产品型号 Model	WUK5N		
尺寸Size	宽	高	厚
	42.5	46	5.2
产品材质 Material	外壳	压接件	螺钉
	尼龙	黄铜	M3
技术参数Technical data			
	IEC	UL	
额定电压 Rated voltage	800	600	
额定电流 Rated current	41	30	
接线容量 Wire Range	刚性 Solid	柔性 Fine Stranded	
平方数 mm ²	0.2-6	0.2-4	
AWG	28-10	28-10	
绝缘阻燃等级 Insulating Flammability Rating	UL94-V0		
颜色 Color	WUK5N Grey 常规 WUK5N Blue 定制		
附件产品 Accessories Product			
端板 Cover Plate		D-WUK4/10	
分组隔片 Partition Plate		ATP-WUK	
隔片 Separating Plate		TS-K	
中心联件 Jumper		FBI 10-6/EB2-6	
边插链接件 Plug-in Bridge		EB3-6/EB10-6	
标记条 Zack Marker Strip		ZB6 横/竖/空白	
标记夹/座 Mark Clip		UBE/D UK-B1 KLM-A	
终端固定件End Clamp		E/UK	

C-01WUK螺钉接线端子



WUK6N

产品信息Product Information			
产品型号 Model	WUK6N		
尺寸Size	宽	高	厚
	42.5	46	8.2
产品材质 Material	外壳	压接件	螺钉
	尼龙	黄铜	M4
技术参数Technical data			
	IEC	UL	
额定电压 Rated voltage	800	600	
额定电流 Rated current	57	45	
接线容量 Wire Range	刚性 Solid	柔性 Fine Stranded	
平方数 mm ²	0.2-10	0.2-6	
AWG	26-8	26-8	
绝缘阻燃等级 Insulating Flammability Rating	UL94-V0		
颜色 Color	WUK6N Grey 常规 WUK6N Blue 定制		
附件产品 Accessories Product			
端板 Cover Plate		D-WUK4/10	
分组隔片 Partition Plate		ATP-WUK	
隔片 Separating Plate		TS-K	
中心联件 Jumper		FBI 10-8/EB2-8	
边插链接件 Plug-in Bridge		EB3-8/EB10-8	
标记条 Zack Marker Strip		ZB8 横/竖/空白	
标记夹/座 Mark Clip		UBE/D UK-B1 KLM-A	
终端固定件 End Clamp		E/UK	

WUK10N

产品信息Product Information			
产品型号 Model	WUK10N		
尺寸Size	宽	高	厚
	42.5	46	10.2
产品材质 Material	外壳	压接件	螺钉
	尼龙	黄铜	M4
技术参数Technical data			
	IEC	UL	
额定电压 Rated voltage	800	600	
额定电流 Rated current	76	63	
接线容量 Wire Range	刚性 Solid	柔性 Fine Stranded	
平方数 mm ²	0.5-16	0.5-10	
AWG	24-6	24-6	
绝缘阻燃等级 Insulating Flammability Rating	UL94-V0		
颜色 Color	WUK10N Grey 常规 WUK10N Blue 定制		
附件产品 Accessories Product			
端板 Cover Plate		D-WUK4/10	
分组隔片 Partition Plate		ATP-WUK	
隔片 Separating Plate		TS-K	
中心联件 Jumper		FBI 10-10/EB2-10	
边插链接件 Plug-in Bridge		EB3-10/EB10-10	
标记条 Zack Marker Strip		ZB10 横/竖/空白	
标记夹/座 Mark Clip		UBE/D UK-B1 KLM-A	
终端固定件 End Clamp		E/UK	

C-01WUK螺钉接线端子



WUK16N

产品信息Product Information			
产品型号 Model	WUK16N		
尺寸Size	宽	高	厚
	42.5	46	12.2
产品材质 Material	外壳	压接件	螺钉
	尼龙	黄铜	M4
技术参数Technical data			
	IEC	UL	
额定电压 Rated voltage	800	600	
额定电流 Rated current	76	63	
接线容量 Wire Range	刚性 Solid	柔性 Fine Stranded	
平方数 mm ²	1.5-25	1.5-16	
AWG	22-4	22-4	
绝缘阻燃等级 Insulating Flammability Rating	UL94-V0		
颜色 Color	WUK16N Grey 常规 WUK16N Blue 定制		
附件产品 Accessories Product			
端板 Cover Plate		D-WUK4/10	
分组隔片 Partition Plate		ATP-WUK	
隔片 Separating Plate		TS-K	
中心联件 Jumper		FBI 10-12	
边插链接件 Plug-in Bridge		—	
标记条 Zack Marker Strip		ZB10 横/竖/空白	
标记夹/座 Mark Clip		UBE/D UK-B1 KLM-A	
终端固定件End Clamp		E/UK	

WUK16G

产品信息Product Information			
产品型号 Model	WUK16G		
尺寸Size	宽	高	厚
	42.5	61.5	12.2
产品材质 Material	外壳	压接件	螺钉
	尼龙	黄铜	M4
技术参数Technical data			
	IEC	UL	
额定电压 Rated voltage	800	600	
额定电流 Rated current	76	63	
接线容量 Wire Range	刚性 Solid	柔性 Fine Stranded	
平方数 mm ²	1.5-25	1.5-16	
AWG	22-4	22-4	
绝缘阻燃等级 Insulating Flammability Rating	UL94-V0		
颜色 Color	WUK16G Grey 常规 WUK16G Blue 定制		
附件产品 Accessories Product			
端板 Cover Plate		D-WUK4/10	
分组隔片 Partition Plate		ATP-WUK	
隔片 Separating Plate		TS-K	
中心联件 Jumper		FBI 10-12	
边插链接件 Plug-in Bridge		—	
标记条 Zack Marker Strip		ZB10 横/竖/空白	
标记夹/座 Mark Clip		UBE/D UK-B1 KLM-A	
终端固定件End Clamp		E/UK	

C-01WUK螺钉接线端子



WUK35N



产品信息Product Information			
产品型号 Model	WUK35N		
尺寸Size	宽	高	厚
	55	50	15.2
产品材质 Material	外壳	压接件	螺钉
	尼龙	黄铜	M6
技术参数Technical data			
	IEC	UL	
额定电压 Rated voltage	1000	1000	
额定电流 Rated current	125	100	
接线容量 Wire Range	刚性 Solid	柔性 Fine Stranded	
平方数 mm ²	1.5-50	1.5-35	
AWG	8-2	8-2	
绝缘阻燃等级 Insulating Flammability Rating	UL94-V0		
颜色 Color	WUK35N Grey 常规 WUK35N Blue 定制		
附件产品 Accessories Product			
端板 Cover Plate		侧封闭/无需端板	
分隔片 Partition Plate		—	
隔片 Separating Plate		TS-KK3	
中心联件 Jumper		FBI 10-15	
边插链接件 Plug-in Bridge		—	
标记条 Zack Marker Strip		ZB10 横/竖/空白	
标记夹/座 Mark Clip		UBE/D UK-B1 KLM-A	
终端固定件End Clamp		E/AL NS35	

WUK35G



产品信息Product Information			
产品型号 Model	WUK35G		
尺寸Size	宽	高	厚
	50	69.5	15.2
产品材质 Material	外壳	压接件	螺钉
	尼龙	黄铜	M6
技术参数Technical data			
	IEC	UL	
额定电压 Rated voltage	1000	1000	
额定电流 Rated current	125	100	
接线容量 Wire Range	刚性 Solid	柔性 Fine Stranded	
平方数 mm ²	1.5-50	1.5-35	
AWG	8-2	8-2	
绝缘阻燃等级 Insulating Flammability Rating	UL94-V0		
颜色 Color	WUK35G Grey 常规 WUK35G Blue 定制		
附件产品 Accessories Product			
端板 Cover Plate		侧封闭/无需端板	
分隔片 Partition Plate		—	
隔片 Separating Plate		TS-KK3	
中心联件 Jumper		FBI 10-15	
边插链接件 Plug-in Bridge		—	
标记条 Zack Marker Strip		ZB10 横/竖/空白	
标记夹/座 Mark Clip		UBE/D UK-B1 KLM-A	
终端固定件End Clamp		E/AL NS35	

C-01WUK螺钉接线端子



WUK50N



产品信息Product Information			
产品型号 Model	WUKH50		
尺寸Size	宽	高	厚
	70.5	76.5	20
产品材质 Material	外壳	压接件	螺钉
	尼龙	黄铜	M6
技术参数Technical data			
	IEC	UL	
额定电压 Rated voltage	1000	600	
额定电流 Rated current	150	—	
接线容量 Wire Range	刚性 Solid	柔性 Fine Stranded	
平方数 mm ²	16-70	25-70	
AWG	6	6	
绝缘阻燃等级 Insulating Flammability Rating	UL94-V0		
颜色 Color	WUKH50 Grey 常规		
附件产品 Accessories Product			
端板 Cover Plate		侧封闭/无需端板	
分组隔片 Partition Plate		—	
隔片 Separating Plate		—	
中心联件 Jumper		—	
边插链接件 Plug-in Bridge		—	
标记条 Zack Marker Strip		ZB10 横/竖/空白	
标记夹/座 Mark Clip		UBE/D UK-B1 KLM-A	
终端固定件End Clamp		E/AL NS35	

WUK95N



产品信息Product Information			
产品型号 Model	WUKH95		
尺寸Size	宽	高	厚
	83	91.2	25
产品材质 Material	外壳	压接件	螺钉
	尼龙	黄铜	M8
技术参数Technical data			
	IEC	UL	
额定电压 Rated voltage	1000	600	
额定电流 Rated current	232	—	
接线容量 Wire Range	刚性 Solid	柔性 Fine Stranded	
平方数 mm ²	25-95	35-95	
AWG	2-4	2-4	
绝缘阻燃等级 Insulating Flammability Rating	UL94-V0		
颜色 Color	WUKH95 Grey 常规		
附件产品 Accessories Product			
端板 Cover Plate		侧封闭/无需端板	
分组隔片 Partition Plate		—	
隔片 Separating Plate		—	
中心联件 Jumper		—	
边插链接件 Plug-in Bridge		—	
标记条 Zack Marker Strip		ZB10 横/竖/空白	
标记夹/座 Mark Clip		UBE/D UK-B1 KLM-A	
终端固定件End Clamp		E/AL NS35	

C-01WUK螺钉接线端子



WUKH150N



产品信息Product Information			
产品型号 Model	WUKH150		
尺寸Size	宽	高	厚
	100	112	31
产品材质 Material	外壳	压接件	螺钉
	尼龙	黄铜	M8
技术参数Technical data			
	IEC	UL	
额定电压 Rated voltage	1000	600	
额定电流 Rated current	309	285	
接线容量 Wire Range	刚性 Solid	柔性 Fine Stranded	
平方数 mm ²	35-150	50-150	
AWG	2-3	2-3	
绝缘阻燃等级 Insulating Flammability Rating	UL94-V0		
颜色 Color	WUKH150 Grey 常规		
附件产品 Accessories Product			
端板 Cover Plate		侧封闭/无需端板	
分隔片 Partition Plate		—	
隔片 Separating Plate		—	
中心联件 Jumper		—	
边插链接件 Plug-in Bridge		—	
标记条 Zack Marker Strip		ZB10 横/竖/空白	
标记夹/座 Mark Clip		UBE/D UK-B1 KLM-A	
终端固定件End Clamp		E/AL NS35	

WUKK3



产品信息Product Information			
产品型号 Model	WUKK3		
尺寸Size	宽	高	厚
	56	62	5.2
产品材质 Material	外壳	压接件	螺钉
	尼龙	黄铜	M3
技术参数Technical data			
	IEC	UL	
额定电压 Rated voltage	500	300	
额定电流 Rated current	24	20	
接线容量 Wire Range	刚性 Solid	柔性 Fine Stranded	
平方数 mm ²	0.2-4	0.2-2.5	
AWG	28-12	28-12	
绝缘阻燃等级 Insulating Flammability Rating	UL94-V0		
颜色 Color	WUKK3 Grey 常规		
附件产品 Accessories Product			
端板 Cover Plate		D-WUKK3/5	
分隔片 Partition Plate		—	
隔片 Separating Plate		TS-KK3	
中心联件 Jumper		FB1 10-5 EB2-5	
边插链接件 Plug-in Bridge		EB3-5 EB10-5	
标记条 Zack Marker Strip		ZB5 横/竖/空白	
标记夹/座 Mark Clip		UBE/D UK-B1 KLM-A	
终端固定件End Clamp		E/UK	

C-01WUK螺钉接线端子



WUKK5



产品信息Product Information			
产品型号 Model	WUKK5		
尺寸Size	宽	高	厚
	56	62	6.2
产品材质 Material	外壳	压接件	螺钉
	尼龙	黄铜	M3
技术参数Technical data			
	IEC	UL	
额定电压 Rated voltage	500	300	
额定电流 Rated current	32	30	
接线容量 Wire Range	刚性 Solid	柔性 Fine Stranded	
平方数 mm ²	0.2-6	0.2-4	
AWG	26-10	26-10	
绝缘阻燃等级 Insulating Flammability Rating	UL94-V0		
颜色 Color	WUKK5 Grey 常规		
附件产品 Accessories Product			
端板 Cover Plate		D-WUKK3/5	
分隔片 Partition Plate		—	
隔片 Separating Plate		TS-KK3	
中心联件 Jumper		FBI 10-6 EB2-6	
边插链接件 Plug-in Bridge		EB3-6 EB10-6	
标记条 Zack Marker Strip		ZB6 横/竖/空白	
标记夹/座 Mark Clip		UBE/D UK-B1 KLM-A	
终端固定件 End Clamp		E/UK	

WUKK3PV上下联通

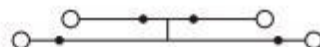

产品信息Product Information			
产品型号 Model	WUKK3PV		
尺寸Size	宽	高	厚
	56	62	5.2
产品材质 Material	外壳	压接件	螺钉
	尼龙	黄铜	M3
技术参数Technical data			
	IEC	UL	
额定电压 Rated voltage	500	300	
额定电流 Rated current	32	30	
接线容量 Wire Range	刚性 Solid	柔性 Fine Stranded	
平方数 mm ²	0.2-4	0.2-2.5	
AWG	28-12	28-12	
绝缘阻燃等级 Insulating Flammability Rating	UL94-V0		
颜色 Color	WUKK3PV Grey 常规		
附件产品 Accessories Product			
端板 Cover Plate		D-WUKK3/5	
分隔片 Partition Plate		—	
隔片 Separating Plate		TS-KK3	
中心联件 Jumper		FBI 10-5 EB2-5	
边插链接件 Plug-in Bridge		EB3-5 EB10-5	
标记条 Zack Marker Strip		ZB5 横/竖/空白	
标记夹/座 Mark Clip		UBE/D UK-B1 KLM-A	
终端固定件 End Clamp		E/UK	

C-01WUK螺钉接线端子



WUKKB5

产品信息Product Information			
产品型号 Model	WUKKB5		
尺寸Size	宽	高	厚
	67	62	6.2
产品材质 Material	外壳	压接件	螺钉
	尼龙	黄铜	M3
技术参数Technical data			
	IEC	UL	
额定电压 Rated voltage	500	300	
额定电流 Rated current	32	30	
接线容量 Wire Range	刚性 Solid	柔性 Fine Stranded	
平方数 mm ²	0.2-4	0.2-2.5	
AWG	26-10	26-10	
绝缘阻燃等级 Insulating Flammability Rating	UL94-V0		
颜色 Color	WUKB5 Grey 常规		
附件产品 Accessories Product			
端板 Cover Plate		D-WUKK3/5	
分隔片 Partition Plate		—	
隔片 Separating Plate		TS-KK3	
中心联件 Jumper		FBI 10-6 EB2-6	
边插链接件 Plug-in Bridge		EB3-6 EB10-6	
标记条 Zack Marker Strip		ZB6 横/竖/空白	
标记夹/座 Mark Clip		UBE/D UK-B1 KLM-A	
终端固定件End Clamp		E/UK	



WMBKKB2.5

产品信息Product Information			
产品型号 Model	WMBKKB2.5		
尺寸Size	宽	高	厚
	62	46.3	5.2
产品材质 Material	外壳	压接件	螺钉
	尼龙	黄铜	M3
技术参数Technical data			
	IEC	UL	
额定电压 Rated voltage	500	300	
额定电流 Rated current	24	20	
接线容量 Wire Range	刚性 Solid	柔性 Fine Stranded	
平方数 mm ²	0.2-4	0.2-2.5	
AWG	28-12	28-12	
绝缘阻燃等级 Insulating Flammability Rating	UL94-V0		
颜色 Color	WMBKKB2.5 Grey 常规		
附件产品 Accessories Product			
端板 Cover Plate		D-WMBKKB2.5	
分隔片 Partition Plate		—	
隔片 Separating Plate		TS-KK3	
中心联件 Jumper		FBI 10-5M EB2-5	
边插链接件 Plug-in Bridge		EB3-5 EB10-5	
标记条 Zack Marker Strip		ZB5 横/竖/空白	
标记夹/座 Mark Clip		UBE/D UK-B1 KLM-A	
终端固定件End Clamp		E/UK	

C-01WUK螺钉接线端子

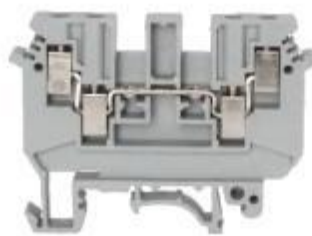

WMBKKB2.5PV



产品信息Product Information			
产品型号 Model	WMBKKB2.5PV		
尺寸Size	宽	高	厚
	72.5	46.5	5.2
产品材质 Material	外壳	压接件	螺钉
	尼龙	黄铜	M3
技术参数Technical data			
	IEC	UL	
额定电压 Rated voltage	500	300	
额定电流 Rated current	24	15	
接线容量 Wire Range	刚性 Solid	柔性 Fine Stranded	
平方数 mm ²	0.2-4	0.2-2.5	
AWG	30-12	30-12	
绝缘阻燃等级 Insulating Flammability Rating	UL94-V0		
颜色 Color	WMBKKB2.5PV Grey 常规		
附件产品 Accessories Product			
端板 Cover Plate		D-WMBKKB2.5	
分隔片 Partition Plate		-	
隔片 Separating Plate		TS-KK3	
中心联件 Jumper		FBI 10-5M EB2-5	
边插链接件 Plug-in Bridge		EB3-5 EB10-5	
标记条 Zack Marker Strip		ZB5 横/竖/空白	
标记夹/座 Mark Clip		UBE/D UK-B1 KLM-A	
终端固定件End Clamp		E/UK	

WUDK4



产品信息Product Information			
产品型号 Model	WUDK4		
尺寸Size	宽	高	厚
	63.5	46.5	6.2
产品材质 Material	外壳	压接件	螺钉
	尼龙	黄铜	M3
技术参数Technical data			
	IEC	UL	
额定电压 Rated voltage	690	600	
额定电流 Rated current	32	30	
接线容量 Wire Range	刚性 Solid	柔性 Fine Stranded	
平方数 mm ²	0.2-6	0.2-4	
AWG	30-10	30-10	
绝缘阻燃等级 Insulating Flammability Rating	UL94-V0		
颜色 Color	WUDK4 Grey 常规		
附件产品 Accessories Product			
端板 Cover Plate		D-WUDK4	
分隔片 Partition Plate		-	
隔片 Separating Plate		TS-KK3	
中心联件 Jumper		FBI 10-6 EB2-6	
边插链接件 Plug-in Bridge		EB3-6 EB10-6	
标记条 Zack Marker Strip		ZB6 横/竖/空白	
标记夹/座 Mark Clip		UBE/D UK-B1 KLM-A	
终端固定件End Clamp		E/UK	

C-01WUK螺钉接线端子



WDIK1.5三层传感器端子

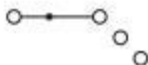

产品信息Product Information			
产品型号 Model	WDIK1.5		
尺寸Size	宽	高	厚
	55	54	6.2
产品材质 Material	外壳	压接件	螺钉
	尼龙	黄铜	M3
技术参数Technical data			
	IEC	UL	
额定电压 Rated voltage	250	300	
额定电流 Rated current	26	15	
接线容量 Wire Range	刚性 Solid	柔性 Fine Stranded	
平方数 mm ²	0.2-4	0.2-2.5	
AWG	28-12	28-12	
绝缘阻燃等级 Insulating Flammability Rating	UL94-V0		
颜色 Color	WDIK1.5 Grey 常规		
附件产品 Accessories Product			
端板 Cover Plate		侧封闭/无需端板	
分组隔片 Partition Plate		—	
隔片 Separating Plate		—	
中心联件 Jumper		FBI 10-6 EB80-DIK-BU	
边插链接件 Plug-in Bridge		EB80-DIK-RD	
标记条 Zack Marker Strip		ZB6 横/竖/空白	
标记夹/座 Mark Clip		UBE/D UK-B1 KLM-A	
终端固定件 End Clamp		E/UK	

WDIKD1.5三层传感器端子

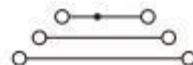

产品信息Product Information			
产品型号 Model	WDIKD1.5		
尺寸Size	宽	高	厚
	72.5	54	6.2
产品材质 Material	外壳	压接件	螺钉
	尼龙	黄铜	M3
技术参数Technical data			
	IEC	UL	
额定电压 Rated voltage	250	300	
额定电流 Rated current	24	15	
接线容量 Wire Range	刚性 Solid	柔性 Fine Stranded	
平方数 mm ²	0.2-4	0.2-2.5	
AWG	28-12	28-12	
绝缘阻燃等级 Insulating Flammability Rating	UL94-V0		
颜色 Color	WDIKD1.5 Grey 常规		
附件产品 Accessories Product			
端板 Cover Plate		侧封闭/无需端板	
分组隔片 Partition Plate		—	
隔片 Separating Plate		—	
中心联件 Jumper		FBI 10-6 EB80-DIK-BU	
边插链接件 Plug-in Bridge		EB80-DIK-RD	
标记条 Zack Marker Strip		ZB6 横/竖/空白	
标记夹/座 Mark Clip		UBE/D UK-B1 KLM-A	
终端固定件 End Clamp		E/UK	

C-01WUK螺钉接线端子



WMBK5E/Z



产品信息Product Information			
产品型号 Model	WMBK5E/Z		
尺寸Size	宽	高	厚
	28	31.4	6.2
产品材质 Material	外壳	压接件	螺钉
	尼龙	黄铜	M3
技术参数Technical data			
	IEC	UL	
额定电压 Rated voltage	500	150	
额定电流 Rated current	41	30	
接线容量 Wire Range	刚性 Solid	柔性 Fine Stranded	
平方数 mm ²	0.2-6	0.2-4	
AWG	26-10	26-10	
绝缘阻燃等级 Insulating Flammability Rating	UL94-V0		
颜色 Color	WMBK5E/Z Grey 常规		
附件产品 Accessories Product			
端板 Cover Plate		D-WMBK3/5	
分组隔片 Partition Plate		—	
隔片 Separating Plate		TS-KK3	
中心联件 Jumper		FBI 10-6 EB2-6	
边插链接件 Plug-in Bridge		EB3-6 EB10-6	
标记条 Zack Marker Strip		ZB6 横/竖/空白	
标记夹/座 Mark Clip		UBE/D UK-B1 KLM-A	
终端固定件End Clamp		E/UK	

WUK5-TWIN



产品信息Product Information			
产品型号 Model	WUK5-TWIN		
尺寸Size	宽	高	厚
	45.7	46	6.2
产品材质 Material	外壳	压接件	螺钉
	尼龙	黄铜	M3
技术参数Technical data			
	IEC	UL	
额定电压 Rated voltage	500	150	
额定电流 Rated current	32	30	
接线容量 Wire Range	刚性 Solid	柔性 Fine Stranded	
平方数 mm ²	0.2-6	0.2-4	
AWG	30-10	30-10	
绝缘阻燃等级 Insulating Flammability Rating	UL94-V0		
颜色 Color	WUK5-TWIN Grey 常规		
附件产品 Accessories Product			
端板 Cover Plate		D-WUK5-TWIN	
分组隔片 Partition Plate		—	
隔片 Separating Plate		TS-KK3	
中心联件 Jumper		FBI 10-6 EB2-6	
边插链接件 Plug-in Bridge		EB3-6 EB10-6	
标记条 Zack Marker Strip		ZB6 横/竖/空白	
标记夹/座 Mark Clip		UBE/D UK-B1 KLM-A	
终端固定件End Clamp		E/UK	

C-01WUK螺钉接线端子



HUK5-MTK-P/P



产品信息Product Information			
产品型号 Model	HUK5-MTK-P/P		
尺寸Size	宽	高	厚
	51	66	6.2
产品材质 Material	外壳	压接件	螺钉
	尼龙	黄铜	M3
技术参数Technical data			
	IEC	UL	
额定电压 Rated voltage	800	600	
额定电流 Rated current	16	15	
接线容量 Wire Range	刚性 Solid	柔性 Fine Stranded	
平方数 mm ²	0.2-6	0.2-4	
AWG	22-12	22-12	
绝缘阻燃等级 Insulating Flammability Rating	UL94-V0		
颜色 Color	HUK5-MTK-P/P Grey 常规		
附件产品 Accessories Product			
端板 Cover Plate		侧封闭/无需端板	
分隔片 Partition Plate		—	
隔片 Separating Plate		—	
中心联件 Jumper		EB2-6 EB3-6	
边插链接件 Plug-in Bridge		EB10-6	
标记条 Zack Marker Strip		ZB6 横/竖/空白	
标记夹/座 Mark Clip		UBE/D UK-B1 KLM-A	
终端固定件End Clamp		E/UK	

WURTK/S



产品信息Product Information			
产品型号 Model	WURTK/S		
尺寸Size	宽	高	厚
	72	51.2	8.2
产品材质 Material	外壳	压接件	螺钉
	尼龙	黄铜	M4
技术参数Technical data			
	IEC	UL	
额定电压 Rated voltage	400	300	
额定电流 Rated current	57	50	
接线容量 Wire Range	刚性 Solid	柔性 Fine Stranded	
平方数 mm ²	0.2-10	0.2-6	
AWG	26-8	26-8	
绝缘阻燃等级 Insulating Flammability Rating	UL94-V0		
颜色 Color	WURTK/S Grey 常规		
附件产品 Accessories Product			
端板 Cover Plate		D-WURTK/S	
分隔片 Partition Plate		—	
隔片 Separating Plate		—	
中心联件 Jumper		FBI 10-RTK/S	
边插链接件 Plug-in Bridge		—	
标记条 Zack Marker Strip		ZB8 横/竖/空白	
标记夹/座 Mark Clip		UBE/D UK-B1 KLM-A	
终端固定件End Clamp		E/UK	

C-01WUK螺钉接线端子



WUK5-HESI

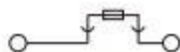

产品信息 Product Information			
产品型号 Model	WUK5-HESI		
尺寸 Size	宽	高	厚
	72	50.8	8.2
产品材质 Material	外壳	压接件	螺钉
	尼龙	黄铜	M3
技术参数 Technical data			
	IEC	UL	
额定电压 Rated voltage	500	300	
额定电流 Rated current	保险丝决定	—	
接线容量 Wire Range	刚性 Solid	柔性 Fine Stranded	
平方数 mm ²	0.2-4	0.2-4	
AWG	30-14	30-14	
绝缘阻燃等级 Insulating Flammability Rating	UL94-V0		
颜色 Color	WUK5-HESI Grey 常规 WUK5-HESI Black 定制		
附件产品 Accessories Product			
端板 Cover Plate		侧封闭/无需端板	
分组隔片 Partition Plate		—	
隔片 Separating Plate		—	
中心联件 Jumper		EB10-8L(尖头型)	
边插链接件 Plug-in Bridge		EB2-8L(尖头型) EB3-8L(尖头型)	
标记条 Zack Marker Strip		ZB8 横/竖/空白	
标记夹/座 Mark Clip		UBE/D UK-B1 KLM-A	
终端固定件 End Clamp		E/UK	

WUK10-HESI

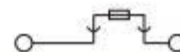

产品信息 Product Information			
产品型号 Model	WUK10-HESI		
尺寸 Size	宽	高	厚
	63	64.5	10.2
产品材质 Material	外壳	压接件	螺钉
	尼龙	黄铜	M4
技术参数 Technical data			
	IEC	UL	
额定电压 Rated voltage	800	600	
额定电流 Rated current	保险丝决定	—	
接线容量 Wire Range	刚性 Solid	柔性 Fine Stranded	
平方数 mm ²	0.5-16	0.5-10	
AWG	20-6	20-6	
绝缘阻燃等级 Insulating Flammability Rating	UL94-V0		
颜色 Color	WUK10-HESI Grey 常规 WUK10-HESI Black 定制		
附件产品 Accessories Product			
端板 Cover Plate		侧封闭/无需端板	
分组隔片 Partition Plate 隔片 Separating Plate		侧封闭/无需端板	
保险丝 (RO)		54 5*20/55 5*25	
保险丝电流(A)		1/2/3/4/5/6/8/10/13 15/16/20	
中心联件 Jumper 边插链接件 Plug-in Bridge		侧封闭/无需端板	
标记条 Zack Marker Strip		ZB10 横/竖/空白	
标记夹/座 Mark Clip		UBE/D UK-B1 KLM-A	
终端固定件 End Clamp		E/UK	

C-02WUK螺钉接线端子



WUSLKG2.5



产品信息Product Information				
产品型号 Model	WUSLKG2.5			
尺寸Size	宽	高	厚	
	43.5	41	6.2	
产品材质 Material	外壳	压接件	接地触点	螺钉
	尼龙	黄铜	镀锡铜	M3
技术参数Technical data				
接线容量 Wire Range	刚性 Solid	柔性 Fine Stranded		
	0.2-4	0.2-2.5		
颜色 Color	黄+绿			
额定电流 Ratedcurrent	34A			
导轨 Rail				

WUSLKG3



产品信息Product Information				
产品型号 Model	WUSLKG3			
尺寸Size	宽	高	厚	
	42.5	42	5.2	
产品材质 Material	外壳	压接件	接地触点	螺钉
	尼龙	黄铜	镀锡铜	M3
技术参数Technical data				
接线容量 Wire Range	刚性 Solid	柔性 Fine Stranded		
	0.2-4	0.2-2.5		
颜色 Color	黄+绿			
额定电流 Ratedcurrent	34A			
导轨 Rail				

WUSLKG5



产品信息Product Information				
产品型号 Model	WUSLKG5			
尺寸Size	宽	高	厚	
	42.5	47	6.2	
产品材质 Material	外壳	压接件	接地触点	螺钉
	尼龙	黄铜	镀锡铜	M3
技术参数Technical data				
接线容量 Wire Range	刚性 Solid	柔性 Fine Stranded		
	0.2-4	0.2-2.5		
颜色 Color	黄+绿			
额定电流 Ratedcurrent	34A			
导轨 Rail				



WUSLKG6



产品信息Product Information				
产品型号 Model	WUSLKG6			
尺寸Size	宽	高	厚	
	42.5	47	8.2	
产品材质 Material	外壳	压接件	接地触点	螺钉
	尼龙	黄铜	镀锡铜	M4
技术参数Technical data				
接线容量 Wire Range	刚性 Solid	柔性 Fine Stranded		
	0.2-10	0.2-6		
颜色 Color	黄+绿			
额定电流 Ratedcurrent	37A			
导轨 Rail				

WUSLKG10

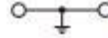

产品信息Product Information				
产品型号 Model	WUSLKG10			
尺寸Size	宽	高	厚	
	42.5	47	10.2	
产品材质 Material	外壳	压接件	接地触点	螺钉
	尼龙	黄铜	镀锡铜	M4
技术参数Technical data				
接线容量 Wire Range	刚性 Solid	柔性 Fine Stranded		
	0.5-16	0.5-10		
颜色 Color	黄+绿			
额定电流 Ratedcurrent	61A			
导轨 Rail				

WUSLKG16



产品信息Product Information				
产品型号 Model	WUSLKG16			
尺寸Size	宽	高	厚	
	42.5	54	12.2	
产品材质 Material	外壳	压接件	接地触点	螺钉
	尼龙	黄铜	镀锡铜	M4
技术参数Technical data				
接线容量 Wire Range	刚性 Solid	柔性 Fine Stranded		
	2.5-25	4-16		
颜色 Color	黄+绿			
额定电流 Ratedcurrent	101A			
导轨 Rail				



WUSLKG35



产品信息Product Information				
产品型号 Model	WUSLKG35			
尺寸Size	宽	高	厚	
	50	62	15.2	
产品材质 Material	外壳	压接件	接地触点	螺钉
	尼龙	黄铜	镀锡铜	M6
技术参数Technical data				
接线容量 Wire Range	刚性 Solid	柔性 Fine Stranded		
	0.75-50	0.75-55		
颜色 Color	黄+绿			
额定电流 Rated current	125A			
导轨 Rail				

WUSLKG50



产品信息Product Information				
产品型号 Model	WUSLKG50			
尺寸Size	宽	高	厚	
	71	83.5	20	
产品材质 Material	外壳	压接件	接地触点	螺钉
	尼龙	黄铜	镀锡铜	M6
技术参数Technical data				
接线容量 Wire Range	刚性 Solid	柔性 Fine Stranded		
	16-50	25-50		
颜色 Color	黄+绿			
额定电流 Ratedcurrent	150A			
导轨 Rail				

WUSLKG95



产品信息Product Information				
产品型号 Model	WUSLKG95			
尺寸Size	宽	高	厚	
	71	99	25	
产品材质 Material	外壳	压接件	接地触点	螺钉
	尼龙	黄铜	镀锡铜	M8
技术参数Technical data				
接线容量 Wire Range	刚性 Solid	柔性 Fine Stranded		
	25-95	35-95		
颜色 Color	黄+绿			
额定电流 Ratedcurrent	232A			
导轨 Rail				

C-03WUK螺钉接线端子

附件	型号	3D图	宽*高*厚	针距	材质	说明
标记条 (横/竖/空白)	ZB4		4.15*10.5*4.2	4.2	PA	下单前请和客服确认尺寸 (手工测量有误差)
	ZB5		5.15*10.5*4.2	5.2		
	ZB6		6.15*10.5*4.2	6.2		
	ZB8		8.15*10.5*4.3	8.2		
	ZB10		10.15*10.5*4.2	10.2		

附件	型号	3D图	位数	针距	材质	说明
中心联件	FBI10-4		10	4.2	镀锡钢	下单前请和客服确认尺寸 (手工测量有误差)
	FBI10-5			5.2		
	FBI10-6N			6.2		
	FBI10-6			6.2		
	FBI10-8	8.2	钢			
	FBI10-10	10.2				
	FBI10-12	12.2				
	FBI10-15	15.2	镀锡钢			
	FBI10-RTK/S	10		8.2		
		4				
3						
2						











附件	型号	3D图	位数	针距	材质	说明
边插式连接件	EB2-5		2	5	铜缆 + PA	下单前请和客服确认尺寸 (手工测量有误差)
	EB2-6			6		
	EB2-8			7		
	EB3-5		3	5		
	EB3-6			6		
	EB3-8			7		
	EB10-5		10	5		
	EB10-8			10		

附件	型号	3D图	长	高	厚	书写面积	说明
标记槽/夹/座	UBE/D		43mm	47mm	15mm	—	
	KLM-A		47mm	37.5mm	10mm	40x5mm	用来对端子组进行标识 安装在终端固定件E/UK 或终端卡件。
	UK-B1		45mm	42.5mm	10mm	40x7mm	用来对端子组进行标识 安装在型或型导轨上

附件	型号	3D图	长	高	厚
固定件	E/UK		43mm	35mm	9.6mm
	E-WD		45mm	35mm	10mm
切换片	TS-K2.5		16.6mm	14.3mm	0.8mm
	TS-K		22.5mm	22.5mm	1mm

C-03WUK螺钉接线端子

C

附件	型号	3D图	宽*高*厚	材质	说明
端板	D-UK1.5		—	PA	下单前 请和客服确认尺寸 (手工测量有误差)
	D-WUK2.5		42.5*30.7*1.5	PA	
	D-WUK4/10		42.5*35.9*1.8	PA	
	D-WUKK3/5		42.5*66.5*2.5	PA	
	D-WMBKKB2.5		40*62*5	PA	
	D-WUKKB3/5		52*67.2*2.5	PA	
	D-UK5/3-TWIN		36*50*2	PA	
	D-WUDK4		35.9*63.5*1.5	PA	
	D-WMBK3/5		30.2*2.5	PA	
	D-WURTK/S		48.5*61*2.2	PA	
分组隔片	ATP-WUK		45.7*56*1.5mm	PA	下单前 请和客服确认尺寸 (手工测量有误差)

C-04WD 6 直插式弹簧接线端子

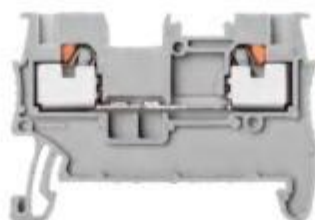

WD6-1.5



产品信息 Product Information			
产品型号 Model	WD6-1.5		
尺寸 Size (mm)	宽	高	厚
	45.2	30.5	3.5
产品材质 Material	外壳	压接件	弹簧
	尼龙	紫铜	钢片
技术参数 Technical data			
	IEC	UL	
额定电压 Rated voltage	500	300	
额定电流 Rated current	17.5	15	
接线容量 Wire Range	刚性 Solid	柔性 Fine Stranded	
平方数 mm ²	0.2-1.5	0.2-1.5	
AWG	26-14	26-14	
绝缘阻燃等级 Insulating Flammability Rating	UL94-V0		
颜色 Color	● WD6-1.5 Grey 常规 ● WD6-1.5 Blue 定制 ● WD6-1.5 Orange 定制		
剥线长度 Wire Stripping Length (mm)	8-10		
附件产品 Accessories Product			
挡板 End-and Intermediate		● D-WD6-1.5 Grey 常规 ● D-WD6-1.5 Orange 定制	
插拔式桥接件 Plug-in Bridge		FBS2-3.5 FBS3-3.5 FBS5-3.5 FBS10-3.5	
标记条 Zack Marker Strip		ZB3 横/竖/空白	
终端固定件 End Clamp		E/UK	
螺丝刀 Screwdriver		0.6*2.4	
导轨 Rail		L1.2-7.5	

WD6-1.5/3



产品信息 Product Information			
产品型号 Model	WD6-1.5/3		
尺寸 Size (mm)	宽	高	厚
	54.3	30.5	3.5
产品材质 Material	外壳	压接件	弹簧
	尼龙	紫铜	钢片
技术参数 Technical data			
	IEC	UL	
额定电压 Rated voltage	500	300	
额定电流 Rated current	17.5	15	
接线容量 Wire Range	刚性 Solid	柔性 Fine Stranded	
平方数 mm ²	0.2-1.5	0.2-1.5	
AWG	26-14	26-14	
绝缘阻燃等级 Insulating Flammability Rating	UL94-V0		
颜色 Color	● WD6-1.5/3 Grey 常规 ● WD6-1.5/3 Blue 定制 ● WD6-1.5/3 Orange 定制		
剥线长度 Wire Stripping Length (mm)	8-10		
附件产品 Accessories Product			
挡板 End-and Intermediate		● D-WD6-1.5 Grey 常规 ● D-WD6-1.5 Orange 定制	
插拔式桥接件 Plug-in Bridge		FBS2-3.5 FBS3-3.5 FBS5-3.5 FBS10-3.5	
标记条 Zack Marker Strip		ZB3 横/竖/空白	
终端固定件 End Clamp		E/UK	
螺丝刀 Screwdriver		0.6*2.4	
导轨 Rail		L1.2-7.5	

C-04 直插式弹簧接线端子

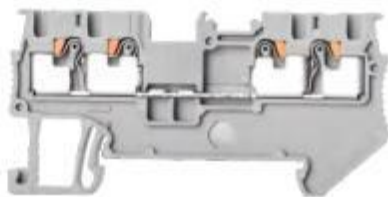

WD6-1.5/4



产品信息Product Information			
产品型号 Model	WD6-1.5/4		
尺寸 Size (mm)	宽	高	厚
	63.2	30.5	3.5
产品材质 Material	外壳	压接件	弹簧
	尼龙	紫铜	铜片
技术参数Technical data			
	IEC	UL	
额定电压 Ratedvoltage	500	300	
额定电流 Ratedcurrent	17.5	15	
接线容量 Wire Range	刚性 Solid	柔性 Fine Stranded	
平方数 mm ²	0.2-1.5	0.2-1.5	
AWG	26-14	26-14	
绝缘阻燃等级 Insulating Flammability Rating	UL94-V0		
颜色 Color	<input type="radio"/> WD6-1.5/4 Grey 常规 <input checked="" type="radio"/> WD6-1.5/4 Blue 定制 <input type="radio"/> WD6-1.5/4 Orange 定制		
剥线长度 Wire Stripping Length (mm)	8-10		
附件产品 Accessories Product			
挡板 End-and Intermediate		<input type="radio"/> D-WD6-1.5/4 Grey 常规 <input checked="" type="radio"/> D-WD6-1.5/4 Orange 定制	
插拔式桥接件 Plug-in Bridge		FBS2-3.5 FBS3-3.5 FBS5-3.5 FBS10-3.5	
标记条 Zack Marker Strip		ZB3 横/竖/空白	
终端固定件End Clamp		E/UK	
螺丝刀 Screwdriver		0.6*2.4	
导轨 Rail		L1.2-7.5	

WD6-1.5/2/2



产品信息Product Information			
产品型号 Model	WD6-1.5/2/2		
尺寸 Size (mm)	宽	高	厚
	65.94	41.35	3.5
产品材质 Material	外壳	压接件	弹簧
	尼龙	紫铜	铜片
技术参数Technical data			
	IEC	UL	
额定电压 Ratedvoltage	500	300	
额定电流 Ratedcurrent	16	15	
接线容量 Wire Range	刚性 Solid	柔性 Fine Stranded	
平方数 mm ²	0.2-1.5	0.2-1.5	
AWG	26-14	26-14	
绝缘阻燃等级 Insulating Flammability Rating	UL94-V0		
颜色 Color	<input type="radio"/> WD6-1.5/2/2 Grey 常规 <input checked="" type="radio"/> WD6-1.5/2/2 Blue 定制 <input type="radio"/> WD6-1.5/2/2 Orange 定制		
剥线长度 Wire Stripping Length (mm)	8-10		
附件产品 Accessories Product			
挡板 End-and Intermediate		<input type="radio"/> D-WD6-1.5/2/2 Grey 常规 <input checked="" type="radio"/> D-WD6-1.5/2/2 Orange 定制	
插拔式桥接件 Plug-in Bridge		FBS2-3.5 FBS3-3.5 FBS5-3.5 FBS10-3.5	
标记条 Zack Marker Strip		ZB3 横/竖/空白	
终端固定件End Clamp		E/UK	
螺丝刀 Screwdriver		0.6*2.4	
导轨 Rail		L1.2-7.5	

C-04WD 6 直插式弹簧接线端子



WD6-2.5



产品信息 Product Information			
产品型号 Model	WD6-2.5		
尺寸 Size (mm)	宽	高	厚
	48.5	35.3	5.2
产品材质 Material	外壳	压接件	弹簧
	尼龙	紫铜	钢片
技术参数 Technical data			
	IEC	UL	
额定电压 Rated voltage	800	600	
额定电流 Rated current	24	20	
接线容量 Wire Range	刚性 Solid	柔性 Fine Stranded	
平方数 mm ²	0.3-4	0.3-2.5	
AWG	24-14	24-14	
绝缘阻燃等级 Insulating Flammability Rating	UL94-V0		
颜色 Color	<input type="radio"/> WD6-2.5 Grey 常规 <input type="radio"/> WD6-2.5 Blue 定制 <input type="radio"/> WD6-2.5 Orange 定制		
剥线长度 Wire Stripping Length (mm)	8-10		
附件产品 Accessories Product			
挡板 End-and Intermediate		<input type="radio"/> D-WD6-2.5Grey 常规 <input type="radio"/> D-WD6-2.5Orange 定制	
插拔式桥接件 Plug-in Bridge		FBS2-5 FBS3-5 FBS5-5 FBS10-5	
标记条 Zack Marker Strip		ZB5 横/竖/空白	
终端固定件 End Clamp		E/UK	
螺丝刀 Screwdriver		0.6*3.5	
导轨 Rail		L1.2-7.5	

WD6-2.5/3



产品信息 Product Information			
产品型号 Model	WD6-2.5/3		
尺寸 Size (mm)	宽	高	厚
	60.5	35.3	5.2
产品材质 Material	外壳	压接件	弹簧
	尼龙	紫铜	钢片
技术参数 Technical data			
	IEC	UL	
额定电压 Rated voltage	800	600	
额定电流 Rated current	24	20	
接线容量 Wire Range	刚性 Solid	柔性 Fine Stranded	
平方数 mm ²	0.3-4	0.3-2.5	
AWG	24-14	24-14	
绝缘阻燃等级 Insulating Flammability Rating	UL94-V0		
颜色 Color	<input type="radio"/> WD6-2.5/3 Grey 常规 <input type="radio"/> WD6-2.5/3 Blue 定制 <input type="radio"/> WD6-2.5/3 Orange 定制		
剥线长度 Wire Stripping Length (mm)	8-10		
附件产品 Accessories Product			
挡板 End-and Intermediate		<input type="radio"/> D-WD6-2.5/3Grey 常规 <input type="radio"/> D-WD6-2.5/3Orange 定制	
插拔式桥接件 Plug-in Bridge		FBS2-5 FBS3-5 FBS5-5 FBS10-5	
标记条 Zack Marker Strip		ZB5 横/竖/空白	
终端固定件 End Clamp		E/UK	
螺丝刀 Screwdriver		0.6*3.5	
导轨 Rail		L1.2-7.5	

C-04 直插式弹簧接线端子



WD6-2.5/4



产品信息Product Information			
产品型号 Model	WD6-2.5/4		
尺寸 Size (mm)	宽	高	厚
	72.2	35.3	5.2
产品材质 Material	外壳	压接件	弹簧
	尼龙	紫铜	钢片
技术参数Technical data			
	IEC	UL	
额定电压 Ratedvoltage	800	600	
额定电流 Ratedcurrent	24	20	
接线容量 Wire Range	刚性 Solid	柔性 Fine Stranded	
平方数 mm ²	0.3-4	0.3-2.5	
AWG	24-14	24-14	
绝缘阻燃等级 Insulating Flammability Rating	UL94-V0		
颜色 Color	● WD6-2.5/4 Grey 常规 ● WD6-2.5/4 Blue 定制 ● WD6-2.5/4 Orange 定制		
剥线长度 Wire Stripping Length (mm)	8-10		
附件产品 Accessories Product			
挡板 End-and Intermediate		● D-WD6-2.5/4Grey 常规 ● D-WD6-2.5/4Orange 定制	
插拔式桥接件 Plug-in Bridge		FBS2-5 FBS3-5 FBS5-5 FBS10-5	
标记条 Zack Marker Strip		ZB5 横/竖/空白	
终端固定件End Clamp		E/UK	
螺丝刀 Screwdriver		0.6*3.5	
导轨 Rail		L1.2-7.5	

WD6-4



产品信息Product Information			
产品型号 Model	WD6-4		
尺寸 Size (mm)	宽	高	厚
	48.5	35.3	6.2
产品材质 Material	外壳	压接件	弹簧
	尼龙	紫铜	钢片
技术参数Technical data			
	IEC	UL	
额定电压 Ratedvoltage	800	600	
额定电流 Ratedcurrent	32	30	
接线容量 Wire Range	刚性 Solid	柔性 Fine Stranded	
平方数 mm ²	0.3-6	0.3-4	
AWG	22-12	22-12	
绝缘阻燃等级 Insulating Flammability Rating	UL94-V0		
颜色 Color	● WD6-4 Grey 常规 ● WD6-4 Blue 定制 ● WD6-4 Orange 定制		
剥线长度 Wire Stripping Length (mm)	10		
附件产品 Accessories Product			
挡板 End-and Intermediate		D-WD6-4Grey 常规 D-WD6-4Orange 定制	
插拔式桥接件 Plug-in Bridge		FBS2-6 FBS3-6 FBS5-6 FBS10-6	
标记条 Zack Marker Strip		ZB6 横/竖/空白	
终端固定件End Clamp		E/UK	
螺丝刀 Screwdriver		0.6*3.5	
导轨 Rail		L1.2-7.5	

C-04 直插式弹簧接线端子



C

产品信息Product Information			
产品型号 Model	WD6-6		
尺寸 Size (mm)	宽	高	厚
	69.7	42.2	8.2
产品材质 Material	外壳	压接件	弹簧
	尼龙	紫铜	钢片
技术参数Technical data			
	IEC	UL	
额定电压 Ratedvoltage	800	600	
额定电流 Ratedcurrent	41	40	
接线容量 Wire Range	刚性 Solid	柔性 Fine Stranded	
平方数 mm ²	0.5-10	0.5-6	
AWG	22-10	22-10	
绝缘阻燃等级 Insulating Flammability Rating	UL94-V0		
颜色 Color	● WD6-6 Grey 常规 ● WD6-6 Blue 定制 ● WD6-6 Orange 定制		
剥线长度 Wire Stripping Length (mm)	12		
附件产品 Accessories Product			
挡板 End-and Intermediate		● D-WD6-6Grey 常规 ● D-WD6-6Orange定制	
插拔式桥接件 Plug-in Bridge		FBS2-8 FBS3-8 FBS10-8	
标记条 Zack Marker Strip		ZB8 横/竖/空白	
终端固定件End Clamp		E/UK	
螺丝刀 Screwdriver		0.4*3.5	
导轨 Rail		L1.2-7.5	

产品信息Product Information			
产品型号 Model	WD6-2.5/2/2		
尺寸 Size (mm)	宽	高	厚
	68.3	46.3	5.2
产品材质 Material	外壳	压接件	弹簧
	尼龙	紫铜	钢片
技术参数Technical data			
	IEC	UL	
额定电压 Ratedvoltage	500	300	
额定电流 Ratedcurrent	24	20	
接线容量 Wire Range	刚性 Solid	柔性 Fine Stranded	
平方数 mm ²	0.3-4	0.3-2.5	
AWG	24-14	24-14	
绝缘阻燃等级 Insulating Flammability Rating	UL94-V0		
颜色 Color	● WD6-2.5/2/2 Grey 常规 ● WD6-2.5/2/2 Blue 定制 ● WD6-2.5/2/2 Orange 定制		
剥线长度 Wire Stripping Length (mm)	8-10		
附件产品 Accessories Product			
挡板 End-and Intermediate		● WD6-2.5/2/2Grey 常规 ● WD6-2.5/2/2Orange定制	
插拔式桥接件 Plug-in Bridge		FBS2-5 FBS3-5 FBS5-5 FBS10-5	
标记条 Zack Marker Strip		ZB5F 横/竖/空白	
终端固定件End Clamp		E/UK	
螺丝刀 Screwdriver		0.6*3.5	
导轨 Rail		L1.2-7.5	

C-04 直插式弹簧接线端子



产品信息 Product Information			
产品型号 Model	WD6-2.5/2/2-DIO		
尺寸 Size (mm)	宽	高	厚
	68.3	46.3	5.2
产品材质 Material	外壳	压接件	弹簧
	尼龙	紫铜	钢片
技术参数 Technical data			
	IEC	UL	
额定电压 Rated voltage	500	300	
额定电流 Rated current	24	20	
接线容量 Wire Range	刚性 Solid	柔性 Fine Stranded	
平方数 mm ²	0.3-4	0.3-2.5	
AWG	24-14	24-14	
绝缘阻燃等级 Insulating Flammability Rating	UL94-V0		
颜色 Color	<ul style="list-style-type: none"> ● WD6-2.5/2/2-DIO Grey 常规 ● WD6-2.5/2/2-DIO Blue 定制 ● WD6-2.5/2/2-DIO Orange 定制 		
剥线长度 Wire Stripping Length (mm)	8-10		
附件产品 Accessories Product			
挡板 End-and Intermediate 	<ul style="list-style-type: none"> ● WD6-2.5/2/2-DIO Grey 常规 ● WD6-2.5/2/2-DIO Orange 定制 		
插拔式桥接件 Plug-in Bridge 	FBS2-5 FBS3-5 FBS5-5 FBS10-5		
标记条 Zack Marker Strip 	ZB5F 横/竖/空白		
终端固定件 End Clamp 	E/UK		
螺丝刀 Screwdriver 	0.6*3.5		
导轨 Rail 	L1.2-7.5		

C-04 直插式弹簧接线端子



C

产品信息Product Information			
产品型号 Model	WD6-2.5PE		
尺寸 Size (mm)	宽	高	厚
	48.5	36.3	5.2
产品材质 Material	外壳	压接件	弹簧
	尼龙	紫铜	钢片
技术参数Technical data			
	IEC	UL	
额定电压 Ratedvoltage	—	—	
额定电流 Ratedcurrent	—	—	
接线容量 Wire Range	刚性 Solid	柔性 Fine Stranded	
平方数 mm ²	0.3-4	0.3-2.5	
AWG	24-14	24-14	
绝缘阻燃等级 Insulating Flammability Rating	UL94-V0		
颜色 Color	● WD6-2.5PE 黄绿 常规		
剥线长度 Wire Stripping Length (mm)	8-10		
附件产品 Accessories Product			
挡板 End-and Intermediate	● D-WD6-2.5 Grey 常规 ● D-WD6-2.5 Orange定制		
插拔式桥接件 Plug-in Bridge	—		
标记条 Zack Marker Strip	ZB5 横/竖/空白		
终端固定件End Clamp	E/UK		
螺丝刀 Screwdriver	0.6*3.5		
导轨 Rail	L1.2-7.5		

产品信息Product Information			
产品型号 Model	WD6-2.5/3PE		
尺寸 Size (mm)	宽	高	厚
	60.5	35.3	5.2
产品材质 Material	外壳	压接件	弹簧
	尼龙	紫铜	钢片
技术参数Technical data			
	IEC	UL	
额定电压 Ratedvoltage	—	—	
额定电流 Ratedcurrent	—	—	
接线容量 Wire Range	刚性 Solid	柔性 Fine Stranded	
平方数 mm ²	0.3-4	0.3-2.5	
AWG	24-14	24-14	
绝缘阻燃等级 Insulating Flammability Rating	UL94-V0		
颜色 Color	● WD6-2.5/3PE 黄绿 常规		
剥线长度 Wire Stripping Length (mm)	8-10		
附件产品 Accessories Product			
挡板 End-and Intermediate	● D-WD6-2.5/3PE Grey 常规 ● D-WD6-2.5/3PE Orange定制		
插拔式桥接件 Plug-in Bridge	—		
标记条 Zack Marker Strip	ZB5 横/竖/空白		
终端固定件End Clamp	E/UK		
螺丝刀 Screwdriver	0.6*3.5		
导轨 Rail	L1.2-7.5		

C-04 直插式弹簧接线端子

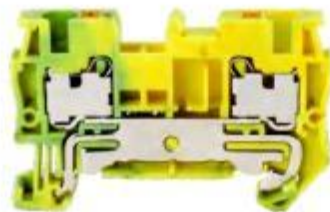

产品信息Product Information			
产品型号 Model	WD6-2.5/4PE		
尺寸 Size (mm)	宽	高	厚
	72.5	35.3	5.2
产品材质 Material	外壳	压接件	弹簧
	尼龙	紫铜	铜片
技术参数Technical data			
	IEC	UL	
额定电压 Ratedvoltage	—	—	
额定电流 Ratedcurrent	—	—	
接线容量 Wire Range	刚性 Solid	柔性 Fine Stranded	
平方数 mm ²	0.3-4	0.3-2.5	
AWG	24-14	24-14	
绝缘阻燃等级 Insulating Flammability Rating	UL94-V0		
颜色 Color	● WD6-2.5/4PE 黄绿 常规		
剥线长度 Wire Striping Length (mm)	8-10		
附件产品 Accessories Product			
挡板 End-and Intermediate	● D-WD6-2.5/4PE Grey 常规 ● D-WD6-2.5/4PE Orange 定制		
插拔式桥接件 Plug-in Bridge	—		
标记条 Zack Marker Strip	ZB5 横/竖/空白		
终端固定件End Clamp	E/UK		
螺丝刀 Screwdriver	0.6*3.5		
导轨 Rail	L1.2-7.5		

产品信息Product Information			
产品型号 Model	WD6-4PE		
尺寸 Size (mm)	宽	高	厚
	56.5	35.3	6.2
产品材质 Material	外壳	压接件	弹簧
	尼龙	紫铜	钢片
技术参数Technical data			
	IEC	UL	
额定电压 Ratedvoltage	—	—	
额定电流 Ratedcurrent	—	—	
接线容量 Wire Range	刚性 Solid	柔性 Fine Stranded	
平方数 mm ²	0.3-6	0.3-4	
AWG	22-12	22-12	
绝缘阻燃等级 Insulating Flammability Rating	UL94-V0		
颜色 Color	● WD6-4PE 黄绿 常规		
剥线长度 Wire Striping Length (mm)	10		
附件产品 Accessories Product			
挡板 End-and Intermediate	● D-WD6-4Grey 常规 ● D-WD6-4Orange 定制		
插拔式桥接件 Plug-in Bridge	—		
标记条 Zack Marker Strip	ZB6 横/竖/空白		
终端固定件End Clamp	E/UK		
螺丝刀 Screwdriver	0.6*3.5		
导轨 Rail	L1.2-7.5		

C-04 直插式弹簧接线端子

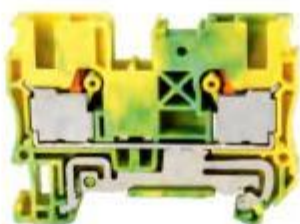

C

产品信息Product Information			
产品型号 Model	WD6-6PE		
尺寸 Size (mm)	宽	高	厚
	69.7	42.2	8.2
产品材质 Material	外壳	压接件	弹簧
	尼龙	紫铜	钢片
技术参数Technical data			
	IEC	UL	
额定电压 Ratedvoltage	—	—	
额定电流 Ratedcurrent	—	—	
接线容量 Wire Range	刚性 Solid	柔性 Fine Stranded	
平方数 mm ²	0.5-10	0.5-6	
AWG	22-10	22-10	
绝缘阻燃等级 Insulating Flammability Rating	UL94-V0		
颜色 Color	● WD6-6PE 黄绿 常规		
剥线长度 Wire Stripping Length (mm)	12		
附件产品 Accessories Product			
挡板 End-and Intermediate	● D-WD6-6Grey 常规 ● D-WD6-6Orange 定制		
插拔式桥接件 Plug-in Bridge	—		
标记条 Zack Marker Strip	ZB8 横/竖/空白		
终端固定件End Clamp	E/UK		
螺丝刀 Screwdriver	0.4*3.5		
导轨 Rail	L1.2-7.5		

产品信息Product Information			
产品型号 Model	WD6-2.5/2/2PE		
尺寸 Size (mm)	宽	高	厚
	68.3	46.3	5.2
产品材质 Material	外壳	压接件	弹簧
	尼龙	紫铜	钢片
技术参数Technical data			
	IEC	UL	
额定电压 Ratedvoltage	—	—	
额定电流 Ratedcurrent	—	—	
接线容量 Wire Range	刚性 Solid	柔性 Fine Stranded	
平方数 mm ²	0.3-4	0.3-2.5	
AWG	24-14	24-14	
绝缘阻燃等级 Insulating Flammability Rating	UL94-V0		
颜色 Color	● WD6-2.5/2/2PE黄绿 常规		
剥线长度 Wire Stripping Length (mm)	8-10		
附件产品 Accessories Product			
挡板 End-and Intermediate	● WD6-2.5/2/2Grey 常规 ● WD6-2.5/2/2Orange 定制		
插拔式桥接件 Plug-in Bridge	—		
标记条 Zack Marker Strip	ZB5F 横/竖/空白		
终端固定件End Clamp	E/UK		
螺丝刀 Screwdriver	0.6*3.5		
导轨 Rail	L1.2-7.5		

C-05 回拉式弹簧接线端子



C

产品信息Product Information			
产品型号 Model	WD5-1.5		
尺寸 Size (mm)	宽	高	厚
	49.1	35.7	4.2
产品材质 Material	外壳	压接件	弹簧
	尼龙	黄铜	钢片
技术参数Technical data			
	IEC	UL	
额定电压 Ratedvoltage	500	300	
额定电流 Ratedcurrent	17.5	15	
接线容量 Wire Range	刚性 Solid	柔性 Fine Stranded	
平方数 mm ²	0.2-1.5	0.2-1.5	
AWG	26-14	26-14	
绝缘阻燃等级 Insulating Flammability Rating	UL94-V0		
颜色 Color	<input type="radio"/> WD5-1.5 Grey 常规 <input type="radio"/> WD5-1.5 Blue 定制 <input type="radio"/> WD5-1.5 Orange 定制		
剥线长度 Wire Stripping Length (mm)	8-10		
附件产品 Accessories Product			
挡板 End-and Intermediate		<input type="radio"/> D-WD5-1.5/2.5 Grey 常规 <input type="radio"/> D-WD5-1.5/2.5 Orange 定制	
插拔式桥接件 Plug-in Bridge		FBS2-4 FBS3-4 FBS10-4	
标记条 Zack Marker Strip		ZB4 横/竖/空白	
终端固定件End Clamp		E/UK	
螺丝刀 Screwdriver		0.4*2.5	
导轨 Rail		L1.2-7.5	

产品信息Product Information			
产品型号 Model	WD5-1.5/3		
尺寸 Size (mm)	宽	高	厚
	61	35.7	4.2
产品材质 Material	外壳	压接件	弹簧
	尼龙	黄铜	钢片
技术参数Technical data			
	IEC	UL	
额定电压 Ratedvoltage	500	300	
额定电流 Ratedcurrent	17.5	15	
接线容量 Wire Range	刚性 Solid	柔性 Fine Stranded	
平方数 mm ²	0.2-1.5	0.2-1.5	
AWG	26-14	26-14	
绝缘阻燃等级 Insulating Flammability Rating	UL94-V0		
颜色 Color	<input type="radio"/> WD5-1.5/3 Grey 常规 <input type="radio"/> WD5-1.5/3 Blue 定制 <input type="radio"/> WD5-1.5/3 Orange 定制		
剥线长度 Wire Stripping Length (mm)	8-10		
附件产品 Accessories Product			
挡板 End-and Intermediate		<input type="radio"/> D-WD5-1.5/2.5 Grey 常规 <input type="radio"/> D-WD5-1.5/2.5 Orange 定制	
插拔式桥接件 Plug-in Bridge		FBS2-4 FBS3-4 FBS10-4	
标记条 Zack Marker Strip		ZB4 横/竖/空白	
终端固定件End Clamp		E/UK	
螺丝刀 Screwdriver		0.4*2.5	
导轨 Rail		L1.2-7.5	

C-05 回拉式弹簧接线端子



产品信息Product Information			
产品型号 Model	WD5-1.5/4		
尺寸 Size (mm)	宽	高	厚
	72.9	35.7	4.2
产品材质 Material	外壳	压接件	弹簧
	尼龙	黄铜	钢片
技术参数Technical data			
	IEC	UL	
额定电压 Ratedvoltage	500	300	
额定电流 Ratedcurrent	17.5	15	
接线容量 Wire Range	刚性 Solid	柔性 Fine Stranded	
平方数 mm ²	0.2-1.5	0.2-1.5	
AWG	26-14	26-14	
绝缘阻燃等级 Insulating Flammability Rating	UL94-V0		
颜色 Color	● WD5-1.5/4 Grey 常规 ● WD5-1.5/4 Blue 定制 ● WD5-1.5/4 Orange 定制		
剥线长度 Wire Striping Length (mm)	8-10		
附件产品 Accessories Product			
挡板 End-and Intermediate		● D-WD5-1.5/2.5 Grey 常规 ● D-WD5-1.5/2.5 Orange 定制	
插拔式桥接件 Plug-in Bridge		FBS2-4 FBS3-4 FBS10-4	
标记条 Zack Marker Strip		ZB4 横/竖/空白	
终端固定件End Clamp		E/UK	
螺丝刀 Screwdriver		0.4*2.5	
导轨 Rail		L1.2-7.5	

产品信息Product Information			
产品型号 Model	WD5-2.5		
尺寸 Size (mm)	宽	高	厚
	49	35.7	5.2
产品材质 Material	外壳	压接件	弹簧
	尼龙	黄铜	钢片
技术参数Technical data			
	IEC	UL	
额定电压 Ratedvoltage	800	600	
额定电流 Ratedcurrent	24	20	
接线容量 Wire Range	刚性 Solid	柔性 Fine Stranded	
平方数 mm ²	0.2-4	0.2-2.5	
AWG	28-12	28-12	
绝缘阻燃等级 Insulating Flammability Rating	UL94-V0		
颜色 Color	● WD5-2.5 Grey 常规 ● WD5-2.5 Blue 定制 ● WD5-2.5 Orange 定制		
剥线长度 Wire Striping Length (mm)	8-10		
附件产品 Accessories Product			
挡板 End-and Intermediate		● D-WD5-1.5/2.5 Grey 常规 ● D-WD5-1.5/2.5 Orange 定制	
插拔式桥接件 Plug-in Bridge		FBS2-5 FBS3-5 FBS5-5 FBS10-5	
标记条 Zack Marker Strip		ZB5 横/竖/空白	
终端固定件End Clamp		E/UK	
螺丝刀 Screwdriver		0.6*3.5	
导轨 Rail		L1.2-7.5	

C-05 回拉式弹簧接线端子



产品信息Product Information			
产品型号 Model	WD5-2.5/3		
尺寸 Size (mm)	宽	高	厚
	61	35.7	5.2
产品材质 Material	外壳	压接件	弹簧
	尼龙	黄铜	钢片
技术参数Technical data			
	IEC	UL	
额定电压 Ratedvoltage	800	600	
额定电流 Ratedcurrent	24	20	
接线容量 Wire Range	刚性 Solid	柔性 Fine Stranded	
平方数 mm ²	0.2-4	0.2-2.5	
AWG	28-12	28-12	
绝缘阻燃等级 Insulating Flammability Rating	UL94-V0		
颜色 Color	<ul style="list-style-type: none"> ● WD5-2.5/3 Grey 常规 ● WD5-2.5/3 Blue 定制 ● WD5-2.5/3 Orange 定制 		
剥线长度 Wire Striping Length (mm)	8-10		
附件产品 Accessories Product			
挡板 End-and Intermediate	<ul style="list-style-type: none"> ● D-WD5-1.5/2.5 Grey 常规 ● D-WD5-1.5/2.5 Orange 定制 		
插拔式桥接件 Plug-in Bridge	FBS2-5 FBS3-5 FBS5-5 FBS10-5		
标记条 Zack Marker Strip	ZB5 横/竖/空白		
终端固定件End Clamp	E/UK		
螺丝刀 Screwdriver	0.6*3.5		
导轨 Rail	L1.2-7.5		

产品信息Product Information			
产品型号 Model	WD5-2.5/4		
尺寸 Size (mm)	宽	高	厚
	72.9	35.7	5.2
产品材质 Material	外壳	压接件	弹簧
	尼龙	黄铜	钢片
技术参数Technical data			
	IEC	UL	
额定电压 Ratedvoltage	800	600	
额定电流 Ratedcurrent	24	20	
接线容量 Wire Range	刚性 Solid	柔性 Fine Stranded	
平方数 mm ²	0.2-4	0.2-2.5	
AWG	28-12	28-12	
绝缘阻燃等级 Insulating Flammability Rating	UL94-V0		
颜色 Color	<ul style="list-style-type: none"> ● WD5-2.5/4 Grey 常规 ● WD5-2.5/4 Blue 定制 ● WD5-2.5/4 Orange 定制 		
剥线长度 Wire Striping Length (mm)	8-10		
附件产品 Accessories Product			
挡板 End-and Intermediate	<ul style="list-style-type: none"> ● D-WD5-1.5/2.5 Grey 常规 ● D-WD5-1.5/2.5 Orange 定制 		
插拔式桥接件 Plug-in Bridge	FBS2-5 FBS3-5 FBS5-5 FBS10-5		
标记条 Zack Marker Strip	ZB5 横/竖/空白		
终端固定件End Clamp	E/UK		
螺丝刀 Screwdriver	0.6*3.5		
导轨 Rail	L1.2-7.5		

C-05 回拉式弹簧接线端子



C

产品信息Product Information			
产品型号 Model	WD5-4		
尺寸 Size (mm)	宽	高	厚
	56.5	35.8	6.2
产品材质 Material	外壳	压接件	弹簧
	尼龙	黄铜	钢片
技术参数Technical data			
	IEC	UL	
额定电压 Ratedvoltage	800	600	
额定电流 Ratedcurrent	32	30	
接线容量 Wire Range	刚性 Solid	柔性 Fine Stranded	
平方数 mm ²	0.2-6	0.2-4	
AWG	28-10	28-10	
绝缘阻燃等级 Insulating Flammability Rating	UL94-V0		
颜色 Color	<input type="radio"/> WD5-4 Grey 常规 <input type="radio"/> WD5-4 Blue 定制 <input type="radio"/> WD5-4 Orange 定制		
剥线长度 Wire Striping Length (mm)	8-10		
附件产品 Accessories Product			
挡板 End-and Intermediate	<input type="radio"/> D-WD5-4Grey 常规 <input type="radio"/> D-WD5-4Orange定制		
插拔式桥接件 Plug-in Bridge	FBS2-6 FBS3-6 FBS5-6 FBS10-6		
标记条 Zack Marker Strip	ZB6 横/竖/空白		
终端固定件End Clamp	E/UK		
螺丝刀 Screwdriver	0.6*3.5		
导轨 Rail	L1.2-7.5		

产品信息Product Information			
产品型号 Model	WD5-4/3		
尺寸 Size (mm)	宽	高	厚
	72.1	35.8	6.2
产品材质 Material	外壳	压接件	弹簧
	尼龙	黄铜	钢片
技术参数Technical data			
	IEC	UL	
额定电压 Ratedvoltage	800	600	
额定电流 Ratedcurrent	32	30	
接线容量 Wire Range	刚性 Solid	柔性 Fine Stranded	
平方数 mm ²	0.2-6	0.2-4	
AWG	28-10	28-10	
绝缘阻燃等级 Insulating Flammability Rating	UL94-V0		
颜色 Color	<input type="radio"/> WD5-4/3 Grey 常规 <input type="radio"/> WD5-4/3 Blue 定制 <input type="radio"/> WD5-4/3 Orange 定制		
剥线长度 Wire Striping Length (mm)	8-10		
附件产品 Accessories Product			
挡板 End-and Intermediate	<input type="radio"/> D-WD5-4/3Grey 常规 <input type="radio"/> D-WD5-4/3Orange定制		
插拔式桥接件 Plug-in Bridge	FBS2-6 FBS3-6 FBS5-6 FBS10-6		
标记条 Zack Marker Strip	ZB6 横/竖/空白		
终端固定件End Clamp	E/UK		
螺丝刀 Screwdriver	0.6*3.5		
导轨 Rail	L1.2-7.5		

C-05 回拉式弹簧接线端子



产品信息Product Information			
产品型号 Model	WD5-4/4		
尺寸 Size (mm)	宽	高	厚
	87.7	35.8	6.2
产品材质 Material	外壳	压接件	弹簧
	尼龙	黄铜	钢片
技术参数Technical data			
	IEC	UL	
额定电压 Ratedvoltage	800	600	
额定电流 Ratedcurrent	32	30	
接线容量 Wire Range	刚性 Solid	柔性 Fine Stranded	
平方数 mm ²	0.2-6	0.2-4	
AWG	28-10	28-10	
绝缘阻燃等级 Insulating Flammability Rating	UL94-V0		
颜色 Color	<input type="radio"/> WD5-4/4 Grey 常规 <input type="radio"/> WD5-4/4 Blue 定制 <input type="radio"/> WD5-4/4 Orange 定制		
剥线长度 Wire Striping Length (mm)	8-10		
附件产品 Accessories Product			
挡板 End-and Intermediate	<input type="radio"/> D-WD5-4/4Grey 常规 <input type="radio"/> D-WD5-4/4Orange定制		
插拔式桥接件 Plug-in Bridge	FBS2-6 FBS3-6 FBS5-6 FBS10-6		
标记条 Zack Marker Strip	ZB6 横/竖/空白		
终端固定件End Clamp	E/UK		
螺丝刀 Screwdriver	0.6*3.5		
导轨 Rail	L1.2-7.5		

产品信息Product Information			
产品型号 Model	WD5-6		
尺寸 Size (mm)	宽	高	厚
	69.7	42.2	8.2
产品材质 Material	外壳	压接件	弹簧
	尼龙	黄铜	钢片
技术参数Technical data			
	IEC	UL	
额定电压 Ratedvoltage	800	600	
额定电流 Ratedcurrent	41	35	
接线容量 Wire Range	刚性 Solid	柔性 Fine Stranded	
平方数 mm ²	0.5-10	0.5-6	
AWG	24-8	24-8	
绝缘阻燃等级 Insulating Flammability Rating	UL94-V0		
颜色 Color	<input type="radio"/> WD5-6 Grey 常规 <input type="radio"/> WD5-6 Blue 定制 <input type="radio"/> WD5-6 Orange 定制		
剥线长度 Wire Striping Length (mm)	12		
附件产品 Accessories Product			
挡板 End-and Intermediate	<input type="radio"/> D-WD5-6Grey 常规 <input type="radio"/> D-WD5-6Orange定制		
插拔式桥接件 Plug-in Bridge	FBS2-8 FBS3-8 FBS10-8		
标记条 Zack Marker Strip	ZB8 横/竖/空白		
终端固定件End Clamp	E/UK		
螺丝刀 Screwdriver	0.8*4		
导轨 Rail	L1.2-7.5		

C-05 回拉式弹簧接线端子



C

产品信息Product Information			
产品型号 Model	WD5-6/3		
尺寸 Size (mm)	宽	高	厚
	91.3	42.8	8.2
产品材质 Material	外壳	压接件	弹簧
	尼龙	黄铜	钢片
技术参数Technical data			
	IEC	UL	
额定电压 Ratedvoltage	800	600	
额定电流 Ratedcurrent	41	30	
接线容量 Wire Range	刚性 Solid	柔性 Fine Stranded	
平方数 mm ²	0.5-10	0.5-6	
AWG	24-8	24-8	
绝缘阻燃等级 Insulating Flammability Rating	UL94-V0		
颜色 Color	<input type="radio"/> WD5-6/3 Grey 常规 <input type="radio"/> WD5-6/3 Blue 定制 <input type="radio"/> WD5-6/3 Orange 定制		
剥线长度 Wire Stripping Length (mm)	12		
附件产品 Accessories Product			
挡板 End-and Intermediate	<input type="radio"/> D-WD5-6/3Grey 常规 <input type="radio"/> D-WD5-6/3Orange定制		
插拔式桥接件 Plug-in Bridge	FBS2-8 FBS3-8 FBS5-8 FBS10-8		
标记条 Zack Marker Strip	ZB8 横/竖/空白		
终端固定件End Clamp	E/UK		
螺丝刀 Screwdriver	0.8*4		
导轨 Rail	L1.2-7.5		

产品信息Product Information			
产品型号 Model	WD5-10		
尺寸 Size (mm)	宽	高	厚
	71.8	49.6	10.2
产品材质 Material	外壳	压接件	弹簧
	尼龙	黄铜	钢片
技术参数Technical data			
	IEC	UL	
额定电压 Ratedvoltage	800	600	
额定电流 Ratedcurrent	57	50	
接线容量 Wire Range	刚性 Solid	柔性 Fine Stranded	
平方数 mm ²	1.5-10	1.5-10	
AWG	16-6	16-6	
绝缘阻燃等级 Insulating Flammability Rating	UL94-V0		
颜色 Color	<input type="radio"/> WD5-10 Grey 常规 <input type="radio"/> WD5-10 Blue 定制 <input type="radio"/> WD5-10 Orange 定制		
剥线长度 Wire Stripping Length (mm)	18		
附件产品 Accessories Product			
挡板 End-and Intermediate	<input type="radio"/> D-WD5-10Grey 常规 <input type="radio"/> D-WD5-10Orange定制		
插拔式桥接件 Plug-in Bridge	FBS2-8 FBS3-8 FBS10-8		
标记条 Zack Marker Strip	ZB8 横/竖/空白		
终端固定件End Clamp	E/UK		
螺丝刀 Screwdriver	1.0*5.5		
导轨 Rail	L1.2-7.5		

C-05 回拉式弹簧接线端子



产品信息Product Information			
产品型号 Model	WD5-10/3		
尺寸 Size (mm)	宽	高	厚
	95.4	42.8	10.2
产品材质 Material	外壳	压接件	弹簧
	尼龙	黄铜	钢片
技术参数Technical data			
	IEC	UL	
额定电压 Ratedvoltage	800	600	
额定电流 Ratedcurrent	57	50	
接线容量 Wire Range	刚性 Solid	柔性 Fine Stranded	
平方数 mm ²	1.5-10	1.5-10	
AWG	16-6	16-6	
绝缘阻燃等级 Insulating Flammability Rating	UL94-V0		
颜色 Color	<input type="radio"/> WD5-10/3 Grey 常规 <input type="radio"/> WD5-10/3 Blue 定制 <input type="radio"/> WD5-10/3 Orange 定制		
剥线长度 Wire Striping Length (mm)	8-10		
附件产品 Accessories Product			
挡板 End-and Intermediate	<input type="radio"/> D-WD5-10/3Grey 常规 <input type="radio"/> D-WD5-10/3Orange定制		
插拔式桥接件 Plug-in Bridge	FBS2-10		
标记条 Zack Marker Strip	ZB10 横/竖/空白		
终端固定件End Clamp	E/UK		
螺丝刀 Screwdriver	1.0*5.5		
导轨 Rail	L1.2-7.5		

产品信息Product Information			
产品型号 Model	WD5-16		
尺寸 Size (mm)	宽	高	厚
	81.3	51.3	12.2
产品材质 Material	外壳	压接件	弹簧
	尼龙	黄铜	钢片
技术参数Technical data			
	IEC	UL	
额定电压 Ratedvoltage	800	600	
额定电流 Ratedcurrent	79	65	
接线容量 Wire Range	刚性 Solid	柔性 Fine Stranded	
平方数 mm ²	1.5-10	1.5-6	
AWG	16-4	16-4	
绝缘阻燃等级 Insulating Flammability Rating	UL94-V0		
颜色 Color	<input type="radio"/> WD5-16 Grey 常规 <input type="radio"/> WD5-16 Blue 定制 <input type="radio"/> WD5-16 Orange 定制		
剥线长度 Wire Striping Length (mm)	12		
附件产品 Accessories Product			
挡板 End-and Intermediate	<input type="radio"/> D-WD5-16Grey 常规 <input type="radio"/> D-WD5-16Orange定制		
插拔式桥接件 Plug-in Bridge			
标记条 Zack Marker Strip	ZB10 横/竖/空白		
终端固定件End Clamp	E/UK		
螺丝刀 Screwdriver	1.5*5.5		
导轨 Rail	L1.2-7.5		

C-05 回拉式弹簧接线端子

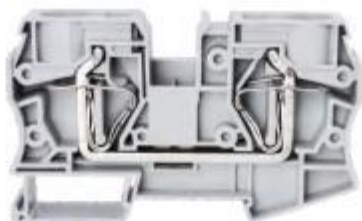

C

产品信息 Product Information			
产品型号 Model	WD5-35		
尺寸 Size (mm)	宽	高	厚
	100.5	59.2	16
产品材质 Material	外壳	压接件	弹簧
	尼龙	黄铜	钢片
技术参数 Technical data			
	IEC	UL	
额定电压 Rated voltage	800	600	
额定电流 Rated current	125	115	
接线容量 Wire Range	刚性 Solid	柔性 Fine Stranded	
平方数 mm ²	2.5-50	2.5-35	
AWG	14-2	14-2	
绝缘阻燃等级 Insulating Flammability Rating	UL 94-V0		
颜色 Color	● WD5-35 Grey 常规		
	● WD5-35 Blue 定制		
	● WD5-35 Orange 定制		
剥线长度 Wire Stripping Length (mm)	12		
附件产品 Accessories Product			
挡板 End-and Intermediate	● 自带挡板 ● 自带挡板		
插拔式桥接件 Plug-in Bridge			
标记条 Zack Marker Strip	ZB10 横/竖/空白		
终端固定件 End Clamp	E/UK		
螺丝刀 Screwdriver	1.5*5.5		
导轨 Rail	L1.2-7.5		

C-05 回拉式弹簧接线端子



产品信息Product Information			
产品型号 Model	WD5-1.5/2/2		
尺寸 Size (mm)	宽	高	厚
	68.3	46.3	4.2
产品材质 Material	外壳	压接件	弹簧
	尼龙	黄铜	钢片
技术参数Technical data			
	IEC	UL	
额定电压 Ratedvoltage	440	300	
额定电流 Ratedcurrent	17.5	15	
接线容量 Wire Range	刚性 Solid	柔性 Fine Stranded	
平方数 mm ²	0.2-1.5	0.2-1.5	
AWG	26-14	26-14	
绝缘阻燃等级 Insulating Flammability Rating	UL94-V0		
颜色 Color	<ul style="list-style-type: none"> ● WD5-1.5/2/2 Grey 常规 ● WD5-1.5/2/2 Blue 定制 ● WD5-1.5/2/2 Orange定制 		
剥线长度 Wire Striping Length (mm)	8-10		
附件产品 Accessories Product			
挡板 End-and Intermediate	<ul style="list-style-type: none"> ● D-WD5-1.5/2/2 Grey 常规 ● D-WD5-1.5/2/2 Orange定制 		
插拔式桥接件 Plug-in Bridge	FBS2-4 FBS3-4 FBS10-4		
标记条 Zack Marker Strip	—		
终端固定件End Clamp	E/UK		
螺丝刀 Screwdriver	0.4*2.5		
导轨 Rail	L1.2-7.5		

产品信息Product Information			
产品型号 Model	WD5-2.5/2/2		
尺寸 Size (mm)	宽	高	厚
	68.3	46.3	5.2
产品材质 Material	外壳	压接件	弹簧
	尼龙	黄铜	钢片
技术参数Technical data			
	IEC	UL	
额定电压 Ratedvoltage	500	300	
额定电流 Ratedcurrent	22	20	
接线容量 Wire Range	刚性 Solid	柔性 Fine Stranded	
平方数 mm ²	0.2-4	0.2-2.5	
AWG	28-12	28-12	
绝缘阻燃等级 Insulating Flammability Rating	UL94-V0		
颜色 Color	<ul style="list-style-type: none"> ● WD5-2.5/2/2 Grey 常规 ● WD5-2.5/2/2 Blue 定制 ● WD5-2.5/2/2 Orange定制 		
剥线长度 Wire Striping Length (mm)	8-10		
附件产品 Accessories Product			
挡板 End-and Intermediate	<ul style="list-style-type: none"> ● WD5-2.5/2/2Grey 常规 ● WD5-2.5/2/2Orange定制 		
插拔式桥接件 Plug-in Bridge	FBS2-5 FBS3-5 FBS5-5 FBS10-5		
标记条 Zack Marker Strip	ZB5F 横/竖/空白		
终端固定件End Clamp	E/UK		
螺丝刀 Screwdriver	0.6*3.5		
导轨 Rail	L1.2-7.5		

C-05 回拉式弹簧接线端子



C

产品信息Product Information			
产品型号 Model	WD5-4/2/2		
尺寸 Size (mm)	宽	高	厚
	84.8	46.3	6.2
产品材质 Material	外壳	压接件	弹簧
	尼龙	黄铜	铜片
技术参数Technical data			
	IEC	UL	
额定电压 Ratedvoltage	500	300	
额定电流 Ratedcurrent	30	30	
接线容量 Wire Range	刚性 Solid	柔性 Fine Stranded	
平方数 mm ²	0.2-4	0.2-2.5	
AWG	28-10	28-10	
绝缘阻燃等级 Insulating Flammability Rating	UL94-V0		
颜色 Color	● WD5-4/2/2 Grey 常规 ● WD5-4/2/2 Blue 定制 ● WD5-4/2/2 Orange 定制		
剥线长度 Wire Stripping Length (mm)	8-10		
附件产品 Accessories Product			
挡板 End-and Intermediate	● WD5-4/2/2Grey 常规 ● WD5-4/2/2Orange定制		
插拔式桥接件 Plug-in Bridge	FBS2-6 FBS3-6 FBS5-6 FBS10-6		
标记条 Zack Marker Strip			
终端固定件End Clamp	E/UK		
螺丝刀 Screwdriver	0.6*3.5		
导轨 Rail	L1.2-7.5		

产品信息Product Information			
产品型号 Model	WD5-2.5/2/2-PV		
尺寸 Size (mm)	宽	高	厚
	68.3	46.3	5.2
产品材质 Material	外壳	压接件	弹簧
	尼龙	黄铜	铜片
技术参数Technical data			
	IEC	UL	
额定电压 Ratedvoltage	500	300	
额定电流 Ratedcurrent	17.5	15	
接线容量 Wire Range	刚性 Solid	柔性 Fine Stranded	
平方数 mm ²	0.2-4	0.2-2.5	
AWG	28-12	28-12	
绝缘阻燃等级 Insulating Flammability Rating	UL94-V0		
颜色 Color	● WD5-2.5/2/2-PV Grey常规 ● WD5-2.5/2/2-PV Blue定制 ● WD5-2.5/2/2-PV Orange定制		
剥线长度 Wire Stripping Length (mm)	8-10		
附件产品 Accessories Product			
挡板 End-and Intermediate	● WD5-2.5/2/2Grey 常规 ● WD5-2.5/2/2Orange定制		
插拔式桥接件 Plug-in Bridge	FBS2-5 FBS3-5 FBS5-5 FBS10-5		
标记条 Zack Marker Strip	ZB5F 横/竖/空白		
终端固定件End Clamp	E/UK		
螺丝刀 Screwdriver	0.6*3.5		
导轨 Rail	L1.2-7.5		

C-05 回拉式弹簧接线端子

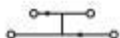

产品信息 Product Information			
产品型号 Model	WD5-2.5/2/2-DIO		
尺寸 Size (mm)	宽	高	厚
	68.3	46.3	5.2
产品材质 Material	外壳	压接件	弹簧
	尼龙	黄铜	钢片
技术参数 Technical data			
	IEC	UL	
额定电压 Rated voltage	500	300	
额定电流 Rated current	由二极管	15	
接线容量 Wire Range	刚性 Solid	柔性 Fine Stranded	
平方数 mm ²	0.2-4	0.2-2.5	
AWG	28-12	28-12	
绝缘阻燃等级 Insulating Flammability Rating	UL94-V0		
颜色 Color	<ul style="list-style-type: none"> ● WD5-2.5/2/2-DIO Grey 常规 ● WD5-2.5/2/2-DIO Blue 定制 ● WD5-2.5/2/2-DIO Orange 定制 		
剥线长度 Wire Stripping Length (mm)	8-10		
附件产品 Accessories Product			
挡板 End-and Intermediate	<ul style="list-style-type: none"> ● WD5-2.5/2/2-DIO Grey 常规 ● WD5-2.5/2/2-DIO Orange 定制 		
插拔式桥接件 Plug-in Bridge	FBS2-5 FBS3-5 FBS5-5 FBS10-5		
标记条 Zack Marker Strip	ZB5F 横/竖/空白		
终端固定件 End Clamp	E/UK		
螺丝刀 Screwdriver	0.6*3.5		
导轨 Rail	L1.2-7.5		

产品信息 Product Information			
产品型号 Model	WD5-2.5/2/3		
尺寸 Size (mm)	宽	高	厚
	100.5	57.1	5.2
产品材质 Material	外壳	压接件	弹簧
	尼龙	黄铜	钢片
技术参数 Technical data			
	IEC	UL	
额定电压 Rated voltage	500	—	
额定电流 Rated current	24	—	
接线容量 Wire Range	刚性 Solid	柔性 Fine Stranded	
平方数 mm ²	0.2-4	0.2-2.5	
AWG	28-12	28-12	
绝缘阻燃等级 Insulating Flammability Rating	UL94-V0		
颜色 Color	<ul style="list-style-type: none"> ● WD5-2.5/2/3 Grey 常规 ● WD5-2.5/2/3 Blue 定制 ● WD5-2.5/2/3 Orange 定制 		
剥线长度 Wire Stripping Length (mm)	8-10		
附件产品 Accessories Product			
挡板 End-and Intermediate	<ul style="list-style-type: none"> ● WD5-2.5/2/3 Grey 常规 ● WD5-2.5/2/3 Orange 定制 		
插拔式桥接件 Plug-in Bridge	FBS2-5 FBS3-5 FBS5-5 FBS10-5		
标记条 Zack Marker Strip	ZB5F 横/竖/空白		
终端固定件 End Clamp	E/UK		
螺丝刀 Screwdriver	0.6*3.5		
导轨 Rail	L1.2-7.5		

C-05 回拉式弹簧接线端子



C

产品信息Product Information			
产品型号 Model	WD5-2.5/2/3-PV		
尺寸 Size (mm)	宽	高	厚
	100.5	57.1	5.2
产品材质 Material	外壳	压接件	弹簧
	尼龙	黄铜	钢片
技术参数Technical data			
	IEC	UL	
额定电压 Ratedvoltage	500	—	
额定电流 Ratedcurrent	24	—	
接线容量 Wire Range	刚性 Solid	柔性 Fine Stranded	
平方数 mm ²	0.2-4	0.2-2.5	
AWG	28-12	28-12	
绝缘阻燃等级 Insulating Flammability Rating	UL94-V0		
颜色 Color	<input type="radio"/> WD5-2.5/2/3-PV Grey 常规 <input type="radio"/> WD5-2.5/2/3-PV Blue 定制 <input type="radio"/> WD5-2.5/2/3-PV Orange 定制		
剥线长度 Wire Stripping Length (mm)	8-10		
附件产品 Accessories Product			
挡板 End-and Intermediate	<input type="radio"/> WD5-2.5/2/3-PV Grey 常规 <input type="radio"/> WD5-2.5/2/3-PV Orange 定制		
插拔式桥接件 Plug-in Bridge	FBS2-5 FBS3-5 FBS5-5 FBS10-5		
标记条 Zack Marker Strip	ZB5F 横/竖/空白		
终端固定件End Clamp	E/UK		
螺丝刀 Screwdriver	0.6*3.5		
导轨 Rail	L1.2-7.5		

产品信息Product Information			
产品型号 Model	WD5-2.5/3X		
尺寸 Size (mm)	宽	高	厚
	51.5	42	5.2
产品材质 Material	外壳	压接件	弹簧
	尼龙	黄铜	钢片
技术参数Technical data			
	IEC	UL	
额定电压 Ratedvoltage	800	600	
额定电流 Ratedcurrent	24	20	
接线容量 Wire Range	刚性 Solid	柔性 Fine Stranded	
平方数 mm ²	0.2-4	0.2-2.5	
AWG	24-14	24-14	
绝缘阻燃等级 Insulating Flammability Rating	UL94-V0		
颜色 Color	<input type="radio"/> WD5-2.5/3X Grey 常规 <input type="radio"/> WD5-2.5/3X Blue 定制 <input type="radio"/> WD5-2.5/3X Orange 定制		
剥线长度 Wire Stripping Length (mm)	8-10		
附件产品 Accessories Product			
挡板 End-and Intermediate	<input type="radio"/> WD5-2.5/3X Grey 常规 <input type="radio"/> WD5-2.5/3X Orange 定制		
插拔式桥接件 Plug-in Bridge	FBS2-6 FBS3-6 FBS5-6 FBS10-6		
标记条 Zack Marker Strip	—		
终端固定件End Clamp	E/UK		
螺丝刀 Screwdriver	0.6*3.5		
导轨 Rail	L1.2-7.5		

C-05 回拉式弹簧接线端子



产品信息Product Information			
产品型号 Model	WD5-1.5PE		
尺寸 Size (mm)	宽	高	厚
	49.1	35.7	4.2
产品材质 Material	外壳	压接件	弹簧
	尼龙	黄铜	钢片
技术参数Technical data			
	IEC	UL	
额定电压 Ratedvoltage	—	—	
额定电流 Ratedcurrent	—	—	
接线容量 Wire Range	刚性 Solid	柔性 Fine Stranded	
平方数 mm ²	0.2-1.5	0.2-1.5	
AWG	26-14	26-14	
绝缘阻燃等级 Insulating Flammability Rating	UL94-V0		
颜色 Color	● WD5-1.5PE 黄绿 常规		
剥线长度 Wire Striping Length (mm)	8-10		
附件产品 Accessories Product			
挡板 End-and Intermediate	● D-WD5-1.5/2.5 Grey 常规 ● D-WD5-1.5/2.5 Orange 定制		
插拔式桥接件 Plug-in Bridge			
标记条 Zack Marker Strip	ZB4 横/竖/空白		
终端固定件End Clamp	E/UK		
螺丝刀 Screwdriver	0.4*2.5		
导轨 Rail	L1.2-7.5		

产品信息Product Information			
产品型号 Model	WD5-2.5PE		
尺寸 Size (mm)	宽	高	厚
	49	35.7	5.2
产品材质 Material	外壳	压接件	弹簧
	尼龙	黄铜	钢片
技术参数Technical data			
	IEC	UL	
额定电压 Ratedvoltage	—	—	
额定电流 Ratedcurrent	—	—	
接线容量 Wire Range	刚性 Solid	柔性 Fine Stranded	
平方数 mm ²	0.2-4	0.2-2.5	
AWG	28-12	28-12	
绝缘阻燃等级 Insulating Flammability Rating	UL94-V0		
颜色 Color	● WD5-2.5PE 黄绿 常规		
剥线长度 Wire Striping Length (mm)	8-10		
附件产品 Accessories Product			
挡板 End-and Intermediate	● D-WD5-1.5/2.5 Grey 常规 ● D-WD5-1.5/2.5 Orange 定制		
插拔式桥接件 Plug-in Bridge			
标记条 Zack Marker Strip	ZB5 横/竖/空白		
终端固定件End Clamp	E/UK		
螺丝刀 Screwdriver	0.6*3.5		
导轨 Rail	L1.2-7.5		

C-05 回拉式弹簧接线端子

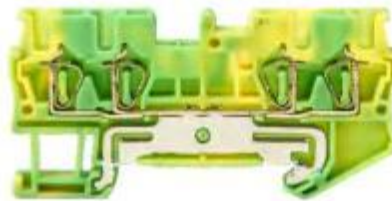

C

产品信息Product Information			
产品型号 Model	WD5-2.5/3PE		
尺寸 Size (mm)	宽	高	厚
	61	35.7	5.2
产品材质 Material	外壳	压接件	弹簧
	尼龙	黄铜	钢片
技术参数Technical data			
	IEC	UL	
额定电压 Ratedvoltage	—	—	
额定电流 Ratedcurrent	—	—	
接线容量 Wire Range	刚性 Solid	柔性 Fine Stranded	
平方数 mm ²	0.2-4	0.2-2.5	
AWG	28-12	28-12	
绝缘阻燃等级 Insulating Flammability Rating	UL94-V0		
颜色 Color	● WD5-2.5/3PE 黄绿 常规		
剥线长度 Wire Stripping Length (mm)	8-10		
附件产品 Accessories Product			
挡板 End-and Intermediate	● D-WD5-1.5/2.5 /3Grey 常规 ● D-WD5-1.5/2.5 /3Orange 定制		
插拔式桥接件 Plug-in Bridge			
标记条 Zack Marker Strip	ZB5 横/竖/空白		
终端固定件End Clamp	E/UK		
螺丝刀 Screwdriver	0.6*3.5		
导轨 Rail	L1.2-7.5		

产品信息Product Information			
产品型号 Model	WD5-2.5/4PE		
尺寸 Size (mm)	宽	高	厚
	72.9	35.7	5.2
产品材质 Material	外壳	压接件	弹簧
	尼龙	黄铜	钢片
技术参数Technical data			
	IEC	UL	
额定电压 Ratedvoltage	—	—	
额定电流 Ratedcurrent	—	—	
接线容量 Wire Range	刚性 Solid	柔性 Fine Stranded	
平方数 mm ²	0.2-4	0.2-2.5	
AWG	28-12	28-12	
绝缘阻燃等级 Insulating Flammability Rating	UL94-V0		
颜色 Color	● WD5-2.5/4PE黄绿 常规		
剥线长度 Wire Stripping Length (mm)	8-10		
附件产品 Accessories Product			
挡板 End-and Intermediate	● D-WD5-1.5/2.5/4 Grey 常规 ● D-WD5-1.5/2.5/4 Orange 定制		
插拔式桥接件 Plug-in Bridge			
标记条 Zack Marker Strip	ZB5 横/竖/空白		
终端固定件End Clamp	E/UK		
螺丝刀 Screwdriver	0.6*3.5		
导轨 Rail	L1.2-7.5		

C-05 回拉式弹簧接线端子



产品信息Product Information			
产品型号 Model	WD5-4PE		
尺寸 Size (mm)	宽	高	厚
	56.5	35.8	6.2
产品材质 Material	外壳	压接件	弹簧
	尼龙	黄铜	钢片
技术参数Technical data			
	IEC	UL	
额定电压 Ratedvoltage	—	—	
额定电流 Ratedcurrent	—	—	
接线容量 Wire Range	刚性 Solid	柔性 Fine Stranded	
平方数 mm ²	0.2-6	0.2-4	
AWG	28-10	28-10	
绝缘阻燃等级 Insulating Flammability Rating	UL94-V0		
颜色 Color	● WD5-4PE 黄绿 常规		
剥线长度 Wire Striping Length (mm)	8-10		
附件产品 Accessories Product			
挡板 End-and Intermediate	● D-WD5-4Grey 常规 ● D-WD5-4Orange 定制		
插拔式桥接件 Plug-in Bridge			
标记条 Zack Marker Strip	ZB6 横/竖/空白		
终端固定件End Clamp	E/UK		
螺丝刀 Screwdriver	0.6*3.5		
导轨 Rail	L1.2-7.5		

产品信息Product Information			
产品型号 Model	WD5-4/3PE		
尺寸 Size (mm)	宽	高	厚
	72.1	35.8	6.2
产品材质 Material	外壳	压接件	弹簧
	尼龙	黄铜	钢片
技术参数Technical data			
	IEC	UL	
额定电压 Ratedvoltage	—	—	
额定电流 Ratedcurrent	—	—	
接线容量 Wire Range	刚性 Solid	柔性 Fine Stranded	
平方数 mm ²	0.2-6	0.2-4	
AWG	28-10	28-10	
绝缘阻燃等级 Insulating Flammability Rating	UL94-V0		
颜色 Color	● WD5-4/3PE 黄绿 常规		
剥线长度 Wire Striping Length (mm)	8-10		
附件产品 Accessories Product			
挡板 End-and Intermediate	● D-WD5-4/3Grey 常规 ● D-WD5-4/3Orange 定制		
插拔式桥接件 Plug-in Bridge			
标记条 Zack Marker Strip	ZB6 横/竖/空白		
终端固定件End Clamp	E/UK		
螺丝刀 Screwdriver	0.6*3.5		
导轨 Rail	L1.2-7.5		

C-05 回拉式弹簧接线端子



C

产品信息Product Information			
产品型号 Model	WD5-4/4PE		
尺寸 Size (mm)	宽	高	厚
	87.7	35.8	6.2
产品材质 Material	外壳	压接件	弹簧
	尼龙	黄铜	钢片
技术参数Technical data			
	IEC	UL	
额定电压 Ratedvoltage	—	—	
额定电流 Ratedcurrent	—	—	
接线容量 Wire Range	刚性 Solid	柔性 Fine Stranded	
平方数 mm ²	0.2-6	0.2-4	
AWG	28-10	28-10	
绝缘阻燃等级 Insulating Flammability Rating	UL94-V0		
颜色 Color	● WD5-4/4PE 黄绿 常规		
剥线长度 Wire Stripping Length (mm)	8-10		
附件产品 Accessories Product			
挡板 End-and Intermediate	● D-WD5-4/4Grey 常规 ● D-WD5-4/4Orange 定制		
插拔式桥接件 Plug-in Bridge			
标记条 Zack Marker Strip	ZB6 横/竖/空白		
终端固定件End Clamp	E/UK		
螺丝刀 Screwdriver	0.6*3.5		
导轨 Rail	L1.2-7.5		

产品信息Product Information			
产品型号 Model	WD5-6PE		
尺寸 Size (mm)	宽	高	厚
	69.7	42.2	8.2
产品材质 Material	外壳	压接件	弹簧
	尼龙	黄铜	钢片
技术参数Technical data			
	IEC	UL	
额定电压 Ratedvoltage	—	—	
额定电流 Ratedcurrent	—	—	
接线容量 Wire Range	刚性 Solid	柔性 Fine Stranded	
平方数 mm ²	0.5-10	0.5-6	
AWG	24-8	24-8	
绝缘阻燃等级 Insulating Flammability Rating	UL94-V0		
颜色 Color	● WD5-6PE 黄绿 常规		
剥线长度 Wire Stripping Length (mm)	12		
附件产品 Accessories Product			
挡板 End-and Intermediate	● D-WD5-6Grey 常规 ● D-WD5-6Orange 定制		
插拔式桥接件 Plug-in Bridge			
标记条 Zack Marker Strip	ZB8 横/竖/空白		
终端固定件End Clamp	E/UK		
螺丝刀 Screwdriver	0.8*4		
导轨 Rail	L1.2-7.5		

C-05 回拉式弹簧接线端子



产品信息Product Information			
产品型号 Model	WD5-6/3PE		
尺寸 Size (mm)	宽	高	厚
	91.3	42.8	8.2
产品材质 Material	外壳	压接件	弹簧
	尼龙	黄铜	钢片
技术参数Technical data			
	IEC	UL	
额定电压 Ratedvoltage	—	—	
额定电流 Ratedcurrent	—	—	
接线容量 Wire Range	刚性 Solid	柔性 Fine Stranded	
平方数 mm ²	0.5-10	0.5-6	
AWG	24-8	24-8	
绝缘阻燃等级 Insulating Flammability Rating	UL94-V0		
颜色 Color	● WD5-6/3PE 黄绿 常规		
剥线长度 Wire Stripping Length (mm)	12		
附件产品 Accessories Product			
挡板 End-and Intermediate	● D-WD5-6/3Grey 常规 ● D-WD5-6/3Orange 定制		
插拔式桥接件 Plug-in Bridge			
标记条 Zack Marker Strip	ZB8 横/竖/空白		
终端固定件End Clamp	E/UK		
螺丝刀 Screwdriver	0.8*4		
导轨 Rail	L1.2-7.5		

产品信息Product Information			
产品型号 Model	WD5-10PE		
尺寸 Size (mm)	宽	高	厚
	71.8	49.6	10.2
产品材质 Material	外壳	压接件	弹簧
	尼龙	黄铜	钢片
技术参数Technical data			
	IEC	UL	
额定电压 Ratedvoltage	—	—	
额定电流 Ratedcurrent	—	—	
接线容量 Wire Range	刚性 Solid	柔性 Fine Stranded	
平方数 mm ²	1.5-10	1.5-10	
AWG	16-6	16-6	
绝缘阻燃等级 Insulating Flammability Rating	UL94-V0		
颜色 Color	● WD5-10PE 黄绿 常规		
剥线长度 Wire Stripping Length (mm)	18		
附件产品 Accessories Product			
挡板 End-and Intermediate	● D-WD5-10Grey 常规 ● D-WD5-10Orange 定制		
插拔式桥接件 Plug-in Bridge			
标记条 Zack Marker Strip	ZB10 横/竖/空白		
终端固定件End Clamp	E/UK		
螺丝刀 Screwdriver	1.0*5.5		
导轨 Rail	L1.2-7.5		





































C-05 回拉式弹簧接线端子



C

产品信息Product Information			
产品型号 Model	WD5-4/2/2PE		
尺寸 Size (mm)	宽	高	厚
	84.8	46.3	6.2
产品材质 Material	外壳	压接件	弹簧
	尼龙	黄铜	钢片
技术参数Technical data			
	IEC	UL	
额定电压 Ratedvoltage	—	—	
额定电流 Ratedcurrent	—	—	
接线容量 Wire Range	刚性 Solid	柔性 Fine Stranded	
平方数 mm ²	0.2-4	0.2-2.5	
AWG	28-10	28-10	
绝缘阻燃等级 Insulating Flammability Rating	UL94-V0		
颜色 Color	● WD5-4/2/2PE 黄绿 常规		
剥线长度 Wire Striping Length (mm)	8-10		
附件产品 Accessories Product			
挡板 End-and Intermediate	● WD5-4/2/2Grey 常规 ● WD5-4/2/2Orange定制		
插拔式桥接件 Plug-in Bridge			
标记条 Zack Marker Strip	ZB5F 横/竖/空白		
终端固定件End Clamp	E/UK		
螺丝刀 Screwdriver	0.6*3.5		
导轨 Rail	L1.2-7.5		

C-06 WD 5系列附件

规格	端子型号	挡板	颜色	标记条	连接件	固定座
1.5平方2通道	WD5-1.5 WD5-1.5PE	D-WD5-1.5/2.5 	● Grey 常规 ● Orange 定制	ZB4 (横/竖)	FBS2-4 	 E/UK  WD1-B
3通道	WD5-1.5/3 WD5-1.5/3PE	D-WD5-1.5/2.5/3 			FBS3-4 	
4通道	WD5-1.5/4	D-WD5-1.5/2.5/4 			FBS10-4 	
双层	WD5-1.5/2/2	D-WD5-2.5/2/2 	● Grey 常规 ● Orange 定制	—	—	
2.5平方2通道	WD5-2.5 WD5-2.5PE	D-WD5-1.5/2.5 	● Grey 常规 ● Orange 定制	ZB5 (横/竖)	FBS2-5 	
3通道	WD5-2.5/3 WD5-2.5/3PE	D-WD5-1.5/2.5/3 			FBS3-5 	
4通道	WD5-2.5/4 WD5-2.5/4PE	D-WD5-1.5/2.5/4 			FBS5-5 	
双层	WD5-2.5/2/2 WD5-2.5/2/2PE WD5-2.5/2/2-PV WD5-2.5/2/2-DIO	D-WD5-2.5/2/2 	● Grey 常规 ● Orange 定制	ZB5F (横/竖)	FBS10-5 	
斜面3通道	WD5-2.5/3X	D-WD5-2.5/3X 	● Grey 常规 ● Orange 定制	ZB5 (横/竖)		
4平方2通道	WD5-4 WD5-4PE	D-WD5-4 	● Grey 常规 ● Orange 定制	ZB6 (横/竖)	FBS2-6 	
3通道	WD5-4/3 WD5-4/3PE	D-WD5-4/3 			FBS3-6 	
4通道	WD5-4/4WD5-4/4PE	D-WD5-4/4 			FBS6-6 	
4通道	WD5-4/4WD5-4/4PE	D-WD5-4/4 			FBS10-6 	
双层	WD5-4/2/2	D-WD5-4/2/2 	● Grey 常规 ● Orange 定制	—	—	
6平方2通道	WD5-6 WD5-6PE	D-WD5-6 	● Grey 常规 ● Orange 定制	ZB8 (横/竖)	FBS2-8 	
6平方3通道	WD5-6/3 WD5-6/3PE	D-WD5-6/3 			FBS3-8 	
10平方2通道	WD5-10 WD5-10PE	D-WD5-10 	● Grey 常规 ● Orange 定制	ZB10 (横/竖)	FBS10-8 	
10平方3通道	WD5-10/3	D-WD5-10/3 			FBS2-10 	
16平方2通道	WD5-16	D-WD5-16 			—	
35平方2通道	WD5-35	侧面封闭不需挡板	—	—	—	

C-07 MBK通用型小型接线端子



C

产品信息Product Information			
产品型号 Model	MBK2.5		
尺寸 Size (mm)	宽	高	厚
	32	28	5.2
产品材质 Material	外壳	压接件	螺丝
	尼龙	黄铜	M3
技术参数Technical data			
	ICE	UL	
额定电压 Ratedvoltage	400	300	
额定电流 Ratedcurrent	24	20	
接线容量 Wire Range	刚性 Solid	柔性 Fine Stranded	
平方数 mm ²	0.2-2.5	0.2-2.5	
W.AG.	24-12	24-12	
绝缘阻燃等级 Insulating Flammability Rating	UL94-V0		
剥线长度 Wire Stripping Length (mm)	8		
附件产品 Accessories Product			
隔板 End-and Intermediate (厚度1.5mm)	D-MBK 2.5		
中心联件 Jumper (带绝缘圈) /最大电流	FBRI 10- 5/24A		
中心联件 Jumper (带卡制定距小套管)	—		
边插链接件 Plug-in Bridge 最大电流		EB 2-5 EB 3-5 EB 10-5/22A	
两端子或桥接端子组开关桥 Two-terminal or bridging terminal group switch bridge	—		
带绝缘垫块桥接件 Bridge connector with insulating pads	—		
绝缘垫块 Cross-over Block	—		
隔片 Separating Plate	—		
分组隔片 Partition Plate(厚2.5mm)		ATP-MBK	
测试插座座 Test Socket	DSB 3/10/4		
标记条 Zack Marker Strip		ZB5	
螺丝刀 Screwdriver		SZS 0.6*3.5	

产品信息Product Information			
产品型号 Model	MBK4		
尺寸 Size (mm)	宽	高	厚
	32	28	6.2
产品材质 Material	外壳	压接件	螺丝
	尼龙	黄铜	M3
技术参数Technical data			
	ICE	UL	
额定电压 Ratedvoltage	500	300	
额定电流 Ratedcurrent	32	30	
接线容量 Wire Range	刚性 Solid	柔性 Fine Stranded	
平方数 mm ²	0.2-4	0.2-4	
W.AG.	24-10	24-10	
绝缘阻燃等级 Insulating Flammability Rating	UL94-V0		
剥线长度 Wire Stripping Length (mm)	8		
附件产品 Accessories Product			
隔板 End-and Intermediate (厚度1.5mm)	D-MBK4		
中心联件 Jumper (带绝缘圈) /最大电流	FBRI 10- 6/32A		
中心联件 Jumper (带卡制定距小套管)	—		
边插链接件 Plug-in Bridge 最大电流		EB 2-5 EB 3-5 EB 10-5/32A	
两端子或桥接端子组开关桥 Two-terminal or bridging terminal group switch bridge	SBRN 2- 7		
带绝缘垫块桥接件 Bridge connector with insulating pads	—		
绝缘垫块 Cross-over Block	—		
隔片 Separating Plate	TS-KK3		
分组隔片 Partition Plate(厚2.5mm)		ATP-PCMB	
测试插座座 Test Socket	DSB 3/10/4		
标记条 Zack Marker Strip		ZB5	
螺丝刀 Screwdriver		SZS 10X4.0	

C-07 MBK通用型小型接线端子



产品信息Product Information

产品信息Product Information

技术参数Technical data

技术参数Technical data

附件产品 Accessories Product

附件产品 Accessories Product

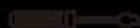

C-07 MBK道用型小型接地端子



产品信息Product Information

产品信息Product Information

技术参数Technical data

技术参数Technical data

附件产品 Accessories Product

附件产品 Accessories Product

C-08 JF5系列组合式接线端子

C



产品型号 Model	JF5-1.5/1
长宽高 Length/width/high(mm)	8*31*29
产品材质 Material	PC
绝缘阻燃等级 Insulating Flammability Rating	UL94-V2
额定电流 Ratedcurrent	17.5A
额定电压 Ratedvoltage	660V
导线截面 Wire Range	0.5*1.5 mm ²



产品型号 Model	JF5-1.5/2
长宽高 Length/width/high(mm)	19.5*31.5*31
产品材质 Material	PC
绝缘阻燃等级 Insulating Flammability Rating	UL94-V2
额定电流 Ratedcurrent	17.5A
额定电压 Ratedvoltage	660V
导线截面 Wire Range	0.5*1.5 mm ²



产品型号 Model	JF5-1.5/3
长宽高 Length/width/high(mm)	28.5*31.5*31
产品材质 Material	PC
绝缘阻燃等级 Insulating Flammability Rating	UL94-V2
额定电流 Ratedcurrent	17.5A
额定电压 Ratedvoltage	660V
导线截面 Wire Range	0.5*1.5 mm ²



产品型号 Model	JF5-1.5/5
长宽高 Length/width/high(mm)	46.5*31.5*31
产品材质 Material	PC
绝缘阻燃等级 Insulating Flammability Rating	UL94-V2
额定电流 Ratedcurrent	17.5A
额定电压 Ratedvoltage	660V
导线截面 Wire Range	0.5*1.5 mm ²



产品型号 Model	JF5-2.5/1
长宽高 Length/width/high(mm)	35*11*32
产品材质 Material	PC
绝缘阻燃等级 Insulating Flammability Rating	UL94-V2
额定电流 Ratedcurrent	24A
额定电压 Ratedvoltage	660V
导线截面 Wire Range	0.5*2.5 mm ²



产品型号 Model	JF5-2.5/2
长宽高 Length/width/high(mm)	37*24.5*32
产品材质 Material	PC
绝缘阻燃等级 Insulating Flammability Rating	UL94-V2
额定电流 Ratedcurrent	24A
额定电压 Ratedvoltage	660V
导线截面 Wire Range	0.5*2.5 mm ²



产品型号 Model	JF5-2.5/3
长宽高 Length/width/high(mm)	37*36*32
产品材质 Material	PC
绝缘阻燃等级 Insulating Flammability Rating	UL94-V2
额定电流 Ratedcurrent	24A
额定电压 Ratedvoltage	660V
导线截面 Wire Range	0.5*2.5 mm ²



产品型号 Model	JF5-2.5/5
长宽高 Length/width/high(mm)	37*59*32
产品材质 Material	PC
绝缘阻燃等级 Insulating Flammability Rating	UL94-V2
额定电流 Ratedcurrent	24A
额定电压 Ratedvoltage	660V
导线截面 Wire Range	0.5*2.5 mm ²



产品型号 Model	JF5-4/1
长宽高 Length/width/high(mm)	13*40*34.5
产品材质 Material	PC
绝缘阻燃等级 Insulating Flammability Rating	UL94-V2
额定电流 Ratedcurrent	32A
额定电压 Ratedvoltage	660V
导线截面 Wire Range	0.75*4 mm ²

C-08 JF5系列组合式接线端子

C



产品型号 Model	JF5-4/2
长宽高 Length/width/high(mm)	27.5*42*32
产品材质 Material	PC
绝缘阻燃等级 Insulating Flammability Rating	UL94-V2
额定电流 Ratedcurrent	32A
额定电压 Ratedvoltage	660V
导线截面 Wire Range	0.75*4mm ²

产品型号 Model	JF5-4/3
长宽高 Length/width/high(mm)	41*42*32
产品材质 Material	PC
绝缘阻燃等级 Insulating Flammability Rating	UL94-V2
额定电流 Ratedcurrent	32A
额定电压 Ratedvoltage	660V
导线截面 Wire Range	0.75*4mm ²

产品型号 Model	JF5-4/5
长宽高 Length/width/high(mm)	67*42*32
产品材质 Material	PC
绝缘阻燃等级 Insulating Flammability Rating	UL94-V2
额定电流 Ratedcurrent	32A
额定电压 Ratedvoltage	660V
导线截面 Wire Range	0.75*4mm ²



产品型号 Model	JF5-6/1
长宽高 Length/width/high(mm)	21*53*41
产品材质 Material	PC
绝缘阻燃等级 Insulating Flammability Rating	UL94-V2
额定电流 Ratedcurrent	41A
额定电压 Ratedvoltage	660V
导线截面 Wire Range	2.5*6 mm ²

产品型号 Model	JF5-6/2
长宽高 Length/width/high(mm)	33*45*43
产品材质 Material	PC
绝缘阻燃等级 Insulating Flammability Rating	UL94-V2
额定电流 Ratedcurrent	41A
额定电压 Ratedvoltage	660V
导线截面 Wire Range	2-6mm ²

产品型号 Model	JF5-6/3
长宽高 Length/width/high(mm)	48*45*43
产品材质 Material	PC
绝缘阻燃等级 Insulating Flammability Rating	UL94-V2
额定电流 Ratedcurrent	41A
额定电压 Ratedvoltage	660V
导线截面 Wire Range	2.5*6mm ²



产品型号 Model	JF5-6/5
长宽高 Length/width/high(mm)	79*45*43
产品材质 Material	PC
绝缘阻燃等级 Insulating Flammability Rating	UL94-V2
额定电流 Ratedcurrent	41A
额定电压 Ratedvoltage	660V
导线截面 Wire Range	2.5*6mm ²

产品型号 Model	JF5-10/1
长宽高 Length/width/high(mm)	19.5*51*50
产品材质 Material	PC
绝缘阻燃等级 Insulating Flammability Rating	UL94-V2
额定电流 Ratedcurrent	57A
额定电压 Ratedvoltage	660V
导线截面 Wire Range	4-10 mm ²

产品型号 Model	JF5-10/2
长宽高 Length/width/high(mm)	38*51*50
产品材质 Material	PC
绝缘阻燃等级 Insulating Flammability Rating	UL94-V2
额定电流 Ratedcurrent	57A
额定电压 Ratedvoltage	660V
导线截面 Wire Range	4-10 mm ²

C-08 JF5系列组合式接线端子

C



产品型号 Model	JF5-10/3
长宽高 Length/width/high(mm)	51*51*50
产品材质 Material	PC
绝缘阻燃等级 Insulating Flammability Rating	UL94-V2
额定电流 Ratedcurrent	57A
额定电压 Ratedvoltage	660V
导线截面 Wire Range	4-10 mm ²



产品型号 Model	JF5-10/5
长宽高 Length/width/high(mm)	92*51*50
产品材质 Material	PC
绝缘阻燃等级 Insulating Flammability Rating	UL94-V2
额定电流 Ratedcurrent	57A
额定电压 Ratedvoltage	660V
导线截面 Wire Range	4-10 mm ²



产品型号 Model	JF5-25/1
长宽高 Length/width/high(mm)	25*61*53.5
产品材质 Material	PC
绝缘阻燃等级 Insulating Flammability Rating	UL94-V2
额定电流 Ratedcurrent	101A
额定电压 Ratedvoltage	660V
导线截面 Wire Range	10-25mm ²



产品型号 Model	JF5-25/2
长宽高 Length/width/high(mm)	48*61*53.5
产品材质 Material	PC
绝缘阻燃等级 Insulating Flammability Rating	UL94-V2
额定电流 Ratedcurrent	101A
额定电压 Ratedvoltage	660V
导线截面 Wire Range	10-25mm ²



产品型号 Model	JF5-25/3
长宽高 Length/width/high(mm)	92*61*51
产品材质 Material	PC
绝缘阻燃等级 Insulating Flammability Rating	UL94-V2
额定电流 Ratedcurrent	101A
额定电压 Ratedvoltage	660V
导线截面 Wire Range	10-25mm ²



产品型号 Model	JF5-25/5
长宽高 Length/width/high(mm)	114*61*51
产品材质 Material	PC
绝缘阻燃等级 Insulating Flammability Rating	UL94-V2
额定电流 Ratedcurrent	101A
额定电压 Ratedvoltage	660V
导线截面 Wire Range	10-25mm ²



产品型号 Model	JF5-50/1
长宽高 Length/width/high(mm)	29.5*70*56
产品材质 Material	PC
绝缘阻燃等级 Insulating Flammability Rating	UL94-V2
额定电流 Ratedcurrent	150A
额定电压 Ratedvoltage	660V
导线截面 Wire Range	10-50mm ²



产品型号 Model	JF5-2.5/S1
长宽高 Length/width/high(mm)	35.8*42*41
产品材质 Material	PC
绝缘阻燃等级 Insulating Flammability Rating	UL94-V2
额定电流 Ratedcurrent	24A
额定电压 Ratedvoltage	660V
导线截面 Wire Range	0.5-2.5 mm ²



产品型号 Model	JF5-2.5/S2
长宽高 Length/width/high(mm)	13*42*41
产品材质 Material	PC
绝缘阻燃等级 Insulating Flammability Rating	UL94-V2
额定电流 Ratedcurrent	24A
额定电压 Ratedvoltage	660V
导线截面 Wire Range	0.5-2.5 mm ²

C-08 JF5系列组合式接线端子

C



产品型号 Model	JF5-2.5/S/3
长宽高 Length/width/high(mm)	10*60*54.5
产品材质 Material	PC
绝缘阻燃等级 Insulating Flammability Rating	UL94-V2
额定电流 Ratedcurrent	24A
额定电压 Ratedvoltage	660V
导线截面 Wire Range	0.5-2.5 mm ²

产品型号 Model	JF5-2.5/RD
长宽高 Length/width/high(mm)	20*46.5*48.5
产品材质 Material	PC
绝缘阻燃等级 Insulating Flammability Rating	UL94-V2
额定电流 Ratedcurrent	24A
额定电压 Ratedvoltage	660V
导线截面 Wire Range	0.5-2.5 mm ²

产品型号 Model	JF5-2.5/JD
长宽高 Length/width/high(mm)	11.5*36*46
产品材质 Material	PC
绝缘阻燃等级 Insulating Flammability Rating	UL94-V2
额定电流 Ratedcurrent	24A
额定电压 Ratedvoltage	660V
导线截面 Wire Range	0.5-2.5 mm ²



产品型号 Model	JF5-1.5/2L
------------	------------

产品型号 Model	JF5-1.5/3L
------------	------------

产品型号 Model	JF5-2.5/2L
------------	------------



产品型号 Model	JF5-2.5/3L
------------	------------

C-09 TK系列接线端子

C



产品型号 Model	TK-10A
长宽高 Length/width/high(mm)	38/8.5/33.5
产品材质 Material	PC
绝缘阻燃等级 Insulating Flammability Rating	UL94-V2
额定电流 Ratedcurrent	10A
额定电压 Ratedvoltage	600V
导线截面 Wire Range	1mm ²
刚性导线/柔性导线 Solid/Fine Stranded	0.5-0.75 0.5-1
终端固定件End Clamp	TK-GD

产品型号 Model	TK-20A
长宽高 Length/width/high(mm)	38/10.1/33.5
产品材质 Material	PC
绝缘阻燃等级 Insulating Flammability Rating	UL94-V2
额定电流 Ratedcurrent	20A
额定电压 Ratedvoltage	600V
导线截面 Wire Range	2mm ²
刚性导线/柔性导线 Solid/Fine Stranded	1-1.5 1-2
终端固定件End Clamp	TK-GD

产品型号 Model	TK-30A
长宽高 Length/width/high(mm)	38/12/36.5
产品材质 Material	PC
绝缘阻燃等级 Insulating Flammability Rating	UL94-V2
额定电流 Ratedcurrent	30A
额定电压 Ratedvoltage	600V
导线截面 Wire Range	5mm ²
刚性导线/柔性导线 Solid/Fine Stranded	2-2.5 2-3
终端固定件End Clamp	TK-GD



产品型号 Model	TK-40A
长宽高 Length/width/high(mm)	38/13.5/42.5
产品材质 Material	PC
绝缘阻燃等级 Insulating Flammability Rating	UL94-V2
额定电流 Ratedcurrent	40A
额定电压 Ratedvoltage	600V
导线截面 Wire Range	4mm ²
刚性导线/柔性导线 Solid/Fine Stranded	3-3.5 3-4
终端固定件End Clamp	TK-GD

产品型号 Model	TK-60A
长宽高 Length/width/high(mm)	48/15.5/42.5
产品材质 Material	PC
绝缘阻燃等级 Insulating Flammability Rating	UL94-V2
额定电流 Ratedcurrent	60A
额定电压 Ratedvoltage	600V
导线截面 Wire Range	10mm ²
刚性导线/柔性导线 Solid/Fine Stranded	5-7.5 5-10
终端固定件End Clamp	TK-GD

产品型号 Model	TK-100A
长宽高 Length/width/high(mm)	53/19.5/42
产品材质 Material	PC
绝缘阻燃等级 Insulating Flammability Rating	UL94-V2
额定电流 Ratedcurrent	100A
额定电压 Ratedvoltage	600V
导线截面 Wire Range	20mm ²
刚性导线/柔性导线 Solid/Fine Stranded	10-15 10-20
终端固定件End Clamp	TK-GD

C-09 TK系列接线端子



产品型号 Model	TK-150A
长宽高 Length/width/high(mm)	43/14/42.5
产品材质 Material	PC
绝缘阻燃等级 Insulating Flammability Rating	UL94-V2
额定电流 Ratedcurrent	150A
额定电压 Ratedvoltage	600V
导线截面 Wire Range	35mm ²
刚性导线/柔性导线 Solid/Fine Stranded	15-20 15-35
终端固定件End Clamp	TK-GD

产品型号 Model	TK-1T15A
长宽高 Length/width/high(mm)	62/8/59.5
产品材质 Material	PC
绝缘阻燃等级 Insulating Flammability Rating	UL94-V2
额定电流 Ratedcurrent	15A
额定电压 Ratedvoltage	600V
导线截面 Wire Range	1.5mm ²
刚性导线/柔性导线 Solid/Fine Stranded	0.75-1 0.75-1.5
终端固定件End Clamp	TK-GD

产品型号 Model	TK-3T15A
长宽高 Length/width/high(mm)	39/25/32
产品材质 Material	PC
绝缘阻燃等级 Insulating Flammability Rating	UL94-V2
额定电流 Ratedcurrent	15A
额定电压 Ratedvoltage	600V
导线截面 Wire Range	1.5mm ²
刚性导线/柔性导线 Solid/Fine Stranded	0.75-1 0.75-1.5
终端固定件End Clamp	TK-GD



产品型号 Model	TK-3T15A
长宽高 Length/width/high(mm)	41/34.5/33.5
产品材质 Material	PC
绝缘阻燃等级 Insulating Flammability Rating	UL94-V2
额定电流 Ratedcurrent	40A
额定电压 Ratedvoltage	600V
导线截面 Wire Range	4mm ²
刚性导线/柔性导线 Solid/Fine Stranded	2-3 2-4
终端固定件End Clamp	TK-GD

C-10 IN系列接线端子



产品型号 Model	IN-12BK
长宽高 Length/width/high(mm)	32/37/20.5
产品材质 Material 外壳/连接件/螺丝	PC/黄铜镀镍/铜镀镍
绝缘阻燃等级 Insulating Flammability Rating	UL94-V2
额定电流 Ratedcurrent	20A
额定电压 Ratedvoltage	600V
导线截面 Wire Range	2.5mm ²
螺丝 Screw	M3
塞规 Plug Gage	A3
扭矩 Torque (Nm)	0.6-0.8

产品型号 Model	IN-13BK
长宽高 Length/width/high(mm)	32/37/26
产品材质 Material 外壳/连接件/螺丝	PC/黄铜镀镍/铜镀镍
绝缘阻燃等级 Insulating Flammability Rating	UL94-V2
额定电流 Ratedcurrent	20A
额定电压 Ratedvoltage	600V
导线截面 Wire Range	2.5mm ²
螺丝 Screw	M3
塞规 Plug Gage	A3
扭矩 Torque (Nm)	0.6-0.8

产品型号 Model	IN-20BK
长宽高 Length/width/high(mm)	32/37/35.5
产品材质 Material 外壳/连接件/螺丝	PC/黄铜镀镍/铜镀镍
绝缘阻燃等级 Insulating Flammability Rating	UL94-V2
额定电流 Ratedcurrent	30A
额定电压 Ratedvoltage	600V
导线截面 Wire Range	4mm ²
螺丝 Screw	M5
塞规 Plug Gage	A5
扭矩 Torque (Nm)	1.5-1.8



产品型号 Model	IN-30BK
长宽高 Length/width/high(mm)	36/48/43
产品材质 Material 外壳/连接件/螺丝	PC/黄铜镀镍/铜镀镍
绝缘阻燃等级 Insulating Flammability Rating	UL94-V2
额定电流 Ratedcurrent	50A
额定电压 Ratedvoltage	600V
导线截面 Wire Range	8mm ²
螺丝 Screw	M5
塞规 Plug Gage	A5
扭矩 Torque (Nm)	2.4-2.7

产品型号 Model	IN-411SC
长宽高 Length/width/high(mm)	36/48/17
产品材质 Material 外壳/连接件/螺丝	PC/黄铜镀镍/铜镀镍
绝缘阻燃等级 Insulating Flammability Rating	UL94-V2
额定电流 Ratedcurrent	60A
额定电压 Ratedvoltage	600V
导线截面 Wire Range	14mm ²
螺丝 Screw	M4
塞规 Plug Gage	B7
扭矩 Torque (Nm)	1.5-1.8

产品型号 Model	IN-60BK
长宽高 Length/width/high(mm)	40/55/23
产品材质 Material 外壳/连接件/螺丝	PC/黄铜镀镍/铜镀镍
绝缘阻燃等级 Insulating Flammability Rating	UL94-V2
额定电流 Ratedcurrent	90A
额定电压 Ratedvoltage	600V
导线截面 Wire Range	22mm ²
螺丝 Screw	M6
塞规 Plug Gage	B9
扭矩 Torque (Nm)	3.2-3.7



产品型号 Model	IN-100BK
长宽高 Length/width/high(mm)	48/73/32
产品材质 Material 外壳/连接件/螺丝	PC/黄铜镀镍/铜镀镍
绝缘阻燃等级 Insulating Flammability Rating	UL94-V2
额定电流 Ratedcurrent	130A
额定电压 Ratedvoltage	600V
导线截面 Wire Range	38mm ²
螺丝 Screw	M8
塞规 Plug Gage	B12
扭矩 Torque (Nm)	15-20

产品型号 Model	IN-200BK
长宽高 Length/width/high(mm)	60/86/40
产品材质 Material 外壳/连接件/螺丝	PC/黄铜镀镍/铜镀镍
绝缘阻燃等级 Insulating Flammability Rating	UL94-V2
额定电流 Ratedcurrent	240A
额定电压 Ratedvoltage	600V
导线截面 Wire Range	100mm ²
螺丝 Screw	M10
塞规 Plug Gage	B15
扭矩 Torque (Nm)	3.2-3.7

C-11 TBR/12 TBD组合接线端子



产品型号 Model	TBR-10A
长宽高 Length/width/high(mm)	33/42/9
产品材质 Material 外壳/连接件/螺丝	PC/黄铜镀镍/铜镀锌
绝缘阻燃等级 Insulating Flammability Rating	UL94-V2
额定电流 Rated current	10A
额定电压 Rated voltage	600V
盖板型号 Top Type	G-10A
导线截面 Wire Range	0.75-1.5mm ²

产品型号 Model	TBR-20A
长宽高 Length/width/high(mm)	33/42/11
产品材质 Material 外壳/连接件/螺丝	PC/黄铜镀镍/铜镀锌
绝缘阻燃等级 Insulating Flammability Rating	UL94-V2
额定电流 Rated current	20A
额定电压 Rated voltage	600V
盖板型号 Top Type	G-20A
导线截面 Wire Range	1.5-2.5mm ²

产品型号 Model	TBR-30A
长宽高 Length/width/high(mm)	33/42/13
产品材质 Material 外壳/连接件/螺丝	PC/黄铜镀镍/铜镀锌
绝缘阻燃等级 Insulating Flammability Rating	UL94-V2
额定电流 Rated current	30A
额定电压 Rated voltage	600V
盖板型号 Top Type	G-30A
导线截面 Wire Range	2.5-4mm ²



产品型号 Model	TBR-60A
长宽高 Length/width/high(mm)	33/42/15
产品材质 Material 外壳/连接件/螺丝	PC/黄铜镀镍/铜镀锌
绝缘阻燃等级 Insulating Flammability Rating	UL94-V2
额定电流 Rated current	60A
额定电压 Rated voltage	600V
盖板型号 Top Type	G-60A
导线截面 Wire Range	4-10mm ²

产品型号 Model	TBR-100A
长宽高 Length/width/high(mm)	41/53/22
产品材质 Material 外壳/连接件/螺丝	PC/黄铜镀镍/铜镀锌
绝缘阻燃等级 Insulating Flammability Rating	UL94-V2
额定电流 Rated current	100A
额定电压 Rated voltage	600V
盖板型号 Top Type	G-100A
导线截面 Wire Range	10-35mm ²

产品型号 Model	TBR-200A
长宽高 Length/width/high(mm)	54.8/62/10
产品材质 Material 外壳/连接件/螺丝	PC/黄铜镀镍/铜镀锌
绝缘阻燃等级 Insulating Flammability Rating	UL94-V2
额定电流 Rated current	200A
额定电压 Rated voltage	600V
盖板型号 Top Type	G-200A
导线截面 Wire Range	10-95mm ²



产品型号 Model	TBD-10A
长宽高 Length/width/high(mm)	54.8/62/8
产品材质 Material 外壳/连接件/螺丝	PC/黄铜镀镍/铜镀锌
绝缘阻燃等级 Insulating Flammability Rating	UL94-V2
额定电流 Rated current	10A
额定电压 Rated voltage	600V
盖板型号 Top Type	G-10A
导线截面 Wire Range	0.5-1.25mm ²

产品型号 Model	TBD-20A
长宽高 Length/width/high(mm)	54.8/62/9.5
产品材质 Material 外壳/连接件/螺丝	PC/黄铜镀镍/铜镀锌
绝缘阻燃等级 Insulating Flammability Rating	UL94-V2
额定电流 Rated current	20A
额定电压 Rated voltage	600V
盖板型号 Top Type	G-20A
导线截面 Wire Range	0.5-2mm ²

产品型号 Model	TBD-30A
长宽高 Length/width/high(mm)	54.8/62/13
产品材质 Material 外壳/连接件/螺丝	PC/黄铜镀镍/铜镀锌
绝缘阻燃等级 Insulating Flammability Rating	UL94-V2
额定电流 Rated current	30A
额定电压 Rated voltage	600V
盖板型号 Top Type	G-30A
导线截面 Wire Range	4-6mm ²

C-13 小母线固定式接线端子

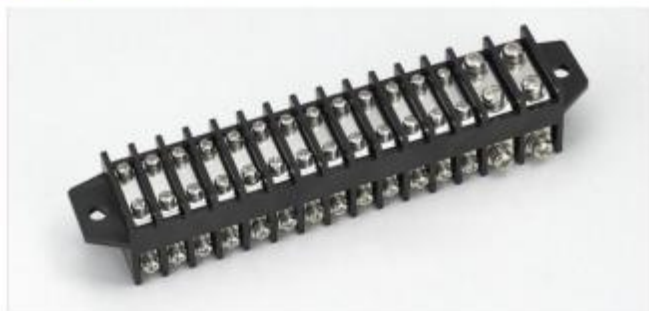

型号	CM1-15系列
长宽高 Length/width/high(mm)	225*40*40
产品材质 Material 外壳/连接件/螺丝	PC/黄铜镀镍/钢镀锌
绝缘阻燃等级 Insulating Flammability Rating	UL94-V2
额定电流 Rated current	41-101A
额定电压 Rated voltage	500V
导线截面 Wire Range	6-25mm ²



型号	MJ1系列
长宽高 Length/width/high(mm)	26.4*50.3*46.6(单片)
产品材质 Material 外壳/连接件/螺丝	PC/黄铜镀镍/钢镀锌
绝缘阻燃等级 Insulating Flammability Rating	UL94-V2
额定电流 Rated current	24A
额定电压 Rated voltage	660V
导线截面 Wire Range	1.5-2.5mm ²

铜棒式小母线组合端子

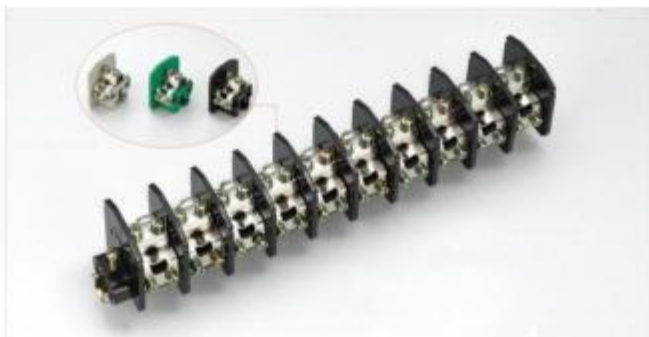

型号	CM1-20系列
长宽高 Length/width/high(mm)	228*50*30
产品材质 Material 外壳/连接件/螺丝	PC/黄铜镀镍/钢镀锌
绝缘阻燃等级 Insulating Flammability Rating	UL94-V2
额定电流 Rated current	41-101A
额定电压 Rated voltage	500V
导线截面 Wire Range	6-25mm ²

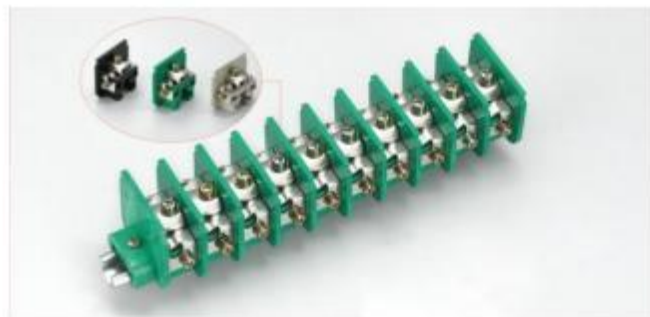

型号	MJ2系列
长宽高 Length/width/high(mm)	20*50*45(单片)
产品材质 Material 外壳/连接件/螺丝	PC/黄铜镀镍/钢镀锌
绝缘阻燃等级 Insulating Flammability Rating	UL94-V2
额定电流 Rated current	24A
额定电压 Rated voltage	660V
导线截面 Wire Range	1.5-2.5mm ²

C-14 TB 系列接线端子

C

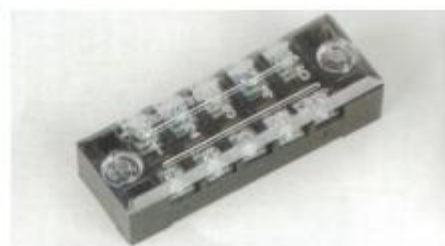

产品型号 Model	TB-1503
长宽高 Length/width/high(mm)	46*22*17.5
产品材质 Material	PC/黄铜镀镍/铜镀锌
外壳/连接件/螺丝/盖板	AS树脂或者PC聚碳
绝缘阻燃等级 Insulating Flammability Rating	UL94-V2
额定电流 Rated current	15A
额定电压 Rated voltage	600V
螺丝规格 Screw specifications	M3
导线截面 Wire Range	0.5-1.5 mm ²

产品型号 Model	TB-1504
长宽高 Length/width/high(mm)	55*22*17.5
产品材质 Material	PC/黄铜镀镍/铜镀锌
外壳/连接件/螺丝/盖板	AS树脂或者PC聚碳
绝缘阻燃等级 Insulating Flammability Rating	UL94-V2
额定电流 Rated current	15A
额定电压 Rated voltage	600V
螺丝规格 Screw specifications	M3
导线截面 Wire Range	0.5-1.5 mm ²

产品型号 Model	TB-1505
长宽高 Length/width/high(mm)	64*22*17.5
产品材质 Material	PC/黄铜镀镍/铜镀锌
外壳/连接件/螺丝/盖板	AS树脂或者PC聚碳
绝缘阻燃等级 Insulating Flammability Rating	UL94-V2
额定电流 Rated current	15A
额定电压 Rated voltage	600V
螺丝规格 Screw specifications	M3
导线截面 Wire Range	0.5-1.5 mm ²

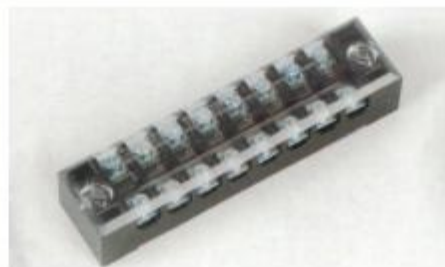
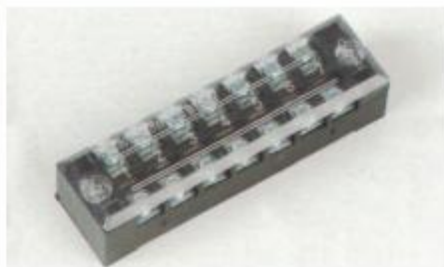
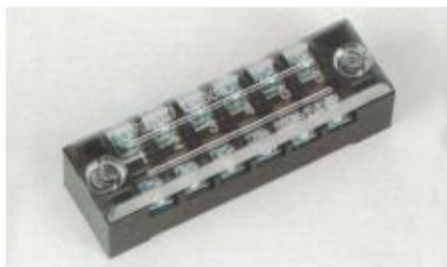

产品型号 Model	TB-1506
长宽高 Length/width/high(mm)	73*22*17.5
产品材质 Material	PC/黄铜镀镍/铜镀锌
外壳/连接件/螺丝/盖板	AS树脂或者PC聚碳
绝缘阻燃等级 Insulating Flammability Rating	UL94-V2
额定电流 Rated current	15A
额定电压 Rated voltage	600V
螺丝规格 Screw specifications	M3
导线截面 Wire Range	0.5-1.5 mm ²

产品型号 Model	TB-1507
长宽高 Length/width/high(mm)	77.6*22*17.5
产品材质 Material	PC/黄铜镀镍/铜镀锌
外壳/连接件/螺丝/盖板	AS树脂或者PC聚碳
绝缘阻燃等级 Insulating Flammability Rating	UL94-V2
额定电流 Rated current	15A
额定电压 Rated voltage	600V
螺丝规格 Screw specifications	M3
导线截面 Wire Range	0.5-1.5 mm ²

产品型号 Model	TB-1508
长宽高 Length/width/high(mm)	90.3*22*17.5
产品材质 Material	PC/黄铜镀镍/铜镀锌
外壳/连接件/螺丝/盖板	AS树脂或者PC聚碳
绝缘阻燃等级 Insulating Flammability Rating	UL94-V2
额定电流 Rated current	15A
额定电压 Rated voltage	600V
螺丝规格 Screw specifications	M3
导线截面 Wire Range	0.5-1.5 mm ²

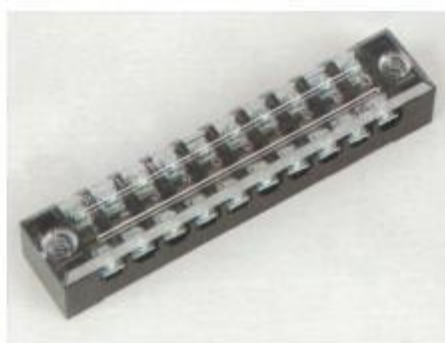

产品型号 Model	TB-1510
长宽高 Length/width/high(mm)	108*22*17.5
产品材质 Material	PC/黄铜镀镍/铜镀锌
外壳/连接件/螺丝/盖板	AS树脂或者PC聚碳
绝缘阻燃等级 Insulating Flammability Rating	UL94-V2
额定电流 Rated current	15A
额定电压 Rated voltage	600V
螺丝规格 Screw specifications	M3
导线截面 Wire Range	0.5-1.5 mm ²

产品型号 Model	TB-1512
长宽高 Length/width/high(mm)	126*22*17.5
产品材质 Material	PC/黄铜镀镍/铜镀锌
外壳/连接件/螺丝/盖板	AS树脂或者PC聚碳
绝缘阻燃等级 Insulating Flammability Rating	UL94-V2
额定电流 Rated current	15A
额定电压 Rated voltage	600V
螺丝规格 Screw specifications	M3
导线截面 Wire Range	0.5-1.5 mm ²

产品型号 Model	TB-1515
长宽高 Length/width/high(mm)	151*22*17.5
产品材质 Material	PC/黄铜镀镍/铜镀锌
外壳/连接件/螺丝/盖板	AS树脂或者PC聚碳
绝缘阻燃等级 Insulating Flammability Rating	UL94-V2
额定电流 Rated current	15A
额定电压 Rated voltage	600V
螺丝规格 Screw specifications	M3
导线截面 Wire Range	0.5-1.5 mm ²

C-14 TB系列接线端子

C

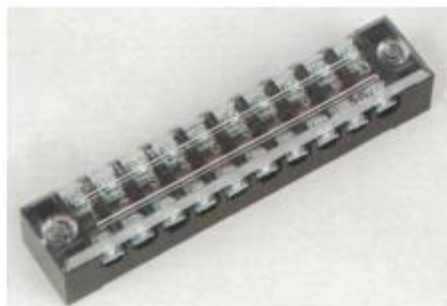

产品型号 Model	TB-1520
长宽高 Length/width/high(mm)	195*22*17.5
产品材质 Material	PC/黄铜镀镍/铜镀锌
外壳/连接件/螺丝/盖板	AS树脂或者PC聚碳
绝缘阻燃等级	UL94-V2
Insulating Flammability Rating	UL94-V2
额定电流 Rated current	15A
额定电压 Rated voltage	600V
螺丝规格 Screw specifications	M3
导线截面 Wire Range	0.5-1.5 mm ²

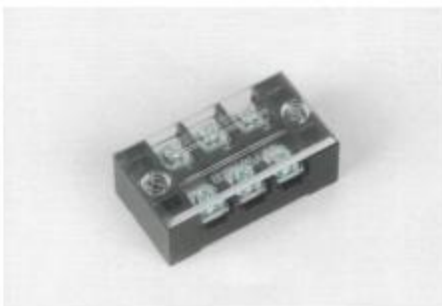

产品型号 Model	TB-2503
长宽高 Length/width/high(mm)	55/30/19
产品材质 Material	PC/黄铜镀镍/铜镀锌
外壳/连接件/螺丝/盖板	AS树脂或者PC聚碳
绝缘阻燃等级	UL94-V2
Insulating Flammability Rating	UL94-V2
额定电流 Rated current	25A
额定电压 Rated voltage	600V
螺丝规格 Screw specifications	M4
导线截面 Wire Range	0.5-2.5 mm ²



产品型号 Model	TB-2504
长宽高 Length/width/high(mm)	80/30/19
产品材质 Material	PC/黄铜镀镍/铜镀锌
外壳/连接件/螺丝/盖板	AS树脂或者PC聚碳
绝缘阻燃等级	UL94-V2
Insulating Flammability Rating	UL94-V2
额定电流 Rated current	25A
额定电压 Rated voltage	600V
螺丝规格 Screw specifications	M4
导线截面 Wire Range	0.5-2.5 mm ²



产品型号 Model	TB-2505
长宽高 Length/width/high(mm)	67/30/19
产品材质 Material	PC/黄铜镀镍/铜镀锌
外壳/连接件/螺丝/盖板	AS树脂或者PC聚碳
绝缘阻燃等级	UL94-V2
Insulating Flammability Rating	UL94-V2
额定电流 Rated current	25A
额定电压 Rated voltage	600V
螺丝规格 Screw specifications	M4
导线截面 Wire Range	0.5-2.5 mm ²

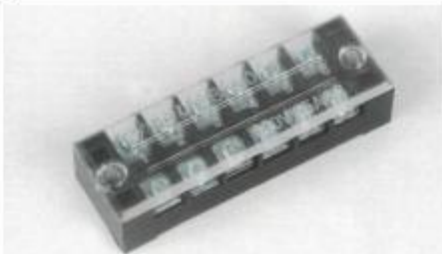

产品型号 Model	TB-2506
长宽高 Length/width/high(mm)	91*30*19
产品材质 Material	PC/黄铜镀镍/铜镀锌
外壳/连接件/螺丝/盖板	AS树脂或者PC聚碳
绝缘阻燃等级	UL94-V2
Insulating Flammability Rating	UL94-V2
额定电流 Rated current	25A
额定电压 Rated voltage	600V
螺丝规格 Screw specifications	M4
导线截面 Wire Range	0.5-2.5 mm ²

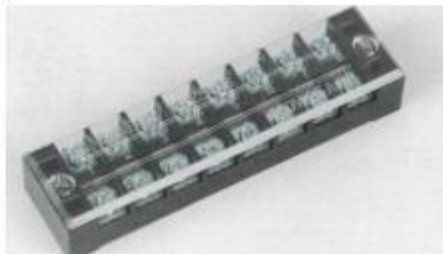

产品型号 Model	TB-2507
长宽高 Length/width/high(mm)	116*30*19
产品材质 Material	PC/黄铜镀镍/铜镀锌
外壳/连接件/螺丝/盖板	AS树脂或者PC聚碳
绝缘阻燃等级	UL94-V2
Insulating Flammability Rating	UL94-V2
额定电流 Rated current	25A
额定电压 Rated voltage	600V
螺丝规格 Screw specifications	M4
导线截面 Wire Range	0.5-2.5 mm ²

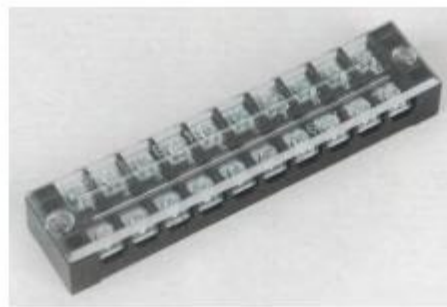

产品型号 Model	TB-2508
长宽高 Length/width/high(mm)	139*30*19
产品材质 Material	PC/黄铜镀镍/铜镀锌
外壳/连接件/螺丝/盖板	AS树脂或者PC聚碳
绝缘阻燃等级	UL94-V2
Insulating Flammability Rating	UL94-V2
额定电流 Rated current	25A
额定电压 Rated voltage	600V
螺丝规格 Screw specifications	M4
导线截面 Wire Range	0.5-2.5 mm ²



产品型号 Model	TB-2510
长宽高 Length/width/high(mm)	164*30*19
产品材质 Material	PC/黄铜镀镍/铜镀锌
外壳/连接件/螺丝/盖板	AS树脂或者PC聚碳
绝缘阻燃等级	UL94-V2
Insulating Flammability Rating	UL94-V2
额定电流 Rated current	25A
额定电压 Rated voltage	600V
螺丝规格 Screw specifications	M4
导线截面 Wire Range	0.5-2.5 mm ²

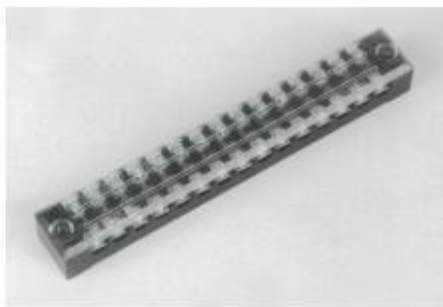

产品型号 Model	TB-2512
长宽高 Length/width/high(mm)	196.5*30*19
产品材质 Material	PC/黄铜镀镍/铜镀锌
外壳/连接件/螺丝/盖板	AS树脂或者PC聚碳
绝缘阻燃等级	UL94-V2
Insulating Flammability Rating	UL94-V2
额定电流 Rated current	25A
额定电压 Rated voltage	600V
螺丝规格 Screw specifications	M4
导线截面 Wire Range	0.5-2.5 mm ²

C-14TB系列接线端子



产品型号 Model	TB-2525
长宽高 Length/width/high(mm)	256*30*19
产品材质 Material	PC/黄铜镀镍/铜镀锌
外壳/连接件/螺丝/盖板	AS树脂或者PC聚碳
绝缘阻燃等级	UL94-V2
额定电流 Rated current	25A
额定电压 Rated voltage	600V
螺丝规格 Screw specifications	M4
导线截面 Wire Range	0.5-2.5 mm ²



产品型号 Model	TB-4503
长宽高 Length/width/high(mm)	70*38*24
产品材质 Material	PC/黄铜镀镍/铜镀锌
外壳/连接件/螺丝/盖板	AS树脂或者PC聚碳
绝缘阻燃等级	UL94-V2
额定电流 Rated current	45A
额定电压 Rated voltage	600V
螺丝规格 Screw specifications	M5
导线截面 Wire Range	0.5-4mm ²



产品型号 Model	TB-4504
长宽高 Length/width/high(mm)	87*38*24
产品材质 Material	PC/黄铜镀镍/铜镀锌
外壳/连接件/螺丝/盖板	AS树脂或者PC聚碳
绝缘阻燃等级	UL94-V2
额定电流 Rated current	45A
额定电压 Rated voltage	600V
螺丝规格 Screw specifications	M5
导线截面 Wire Range	0.5-4mm ²



产品型号 Model	TB-4505
长宽高 Length/width/high(mm)	103*38*24
产品材质 Material	PC/黄铜镀镍/铜镀锌
外壳/连接件/螺丝/盖板	AS树脂或者PC聚碳
绝缘阻燃等级	UL94-V2
额定电流 Rated current	45A
额定电压 Rated voltage	600V
螺丝规格 Screw specifications	M5
导线截面 Wire Range	0.5-4mm ²



产品型号 Model	TB-4506
长宽高 Length/width/high(mm)	120*38*24
产品材质 Material	PC/黄铜镀镍/铜镀锌
外壳/连接件/螺丝/盖板	AS树脂或者PC聚碳
绝缘阻燃等级	UL94-V2
额定电流 Rated current	45A
额定电压 Rated voltage	600V
螺丝规格 Screw specifications	M5
导线截面 Wire Range	0.5-4mm ²

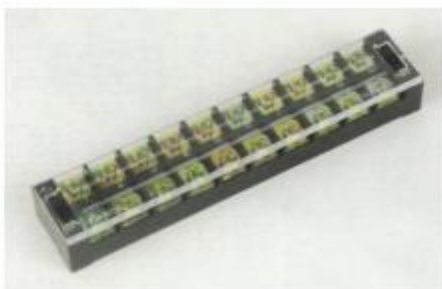

产品型号 Model	TB-4510
长宽高 Length/width/high(mm)	188*38*24
产品材质 Material	PC/黄铜镀镍/铜镀锌
外壳/连接件/螺丝/盖板	AS树脂或者PC聚碳
绝缘阻燃等级	UL94-V2
额定电流 Rated current	45A
额定电压 Rated voltage	600V
螺丝规格 Screw specifications	M5
导线截面 Wire Range	0.5-4mm ²

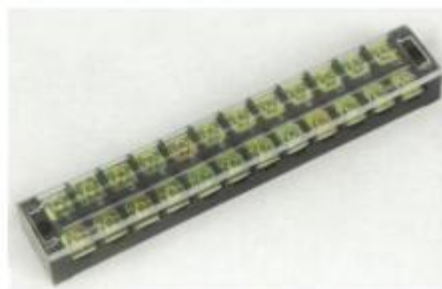

产品型号 Model	TB-4512
长宽高 Length/width/high(mm)	222*38*24
产品材质 Material	PC/黄铜镀镍/铜镀锌
外壳/连接件/螺丝/盖板	AS树脂或者PC聚碳
绝缘阻燃等级	UL94-V2
额定电流 Rated current	45A
额定电压 Rated voltage	600V
螺丝规格 Screw specifications	M5
导线截面 Wire Range	0.5-4mm ²

C-15 TA 系列接线端子

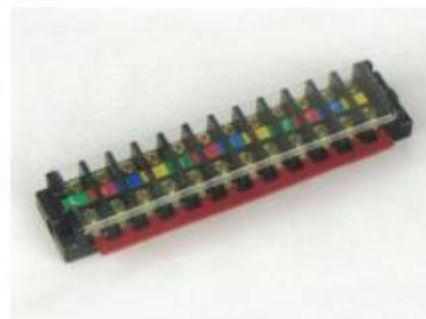
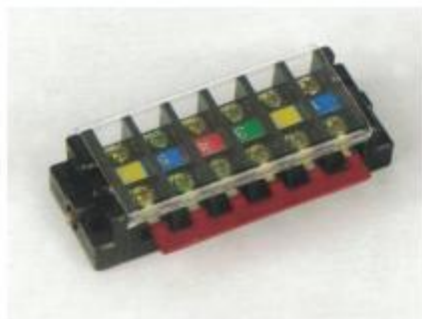

产品型号Model	TA-2003
长高Length/width/high(MM)	59.5*34*21
产品材质 Material	PC/黄铜镀锌/铜镀锌
外壳/连接件/螺丝/盖板	AS树脂或者PC聚碳
绝缘阻燃等级	UL94-V2
Insulating Flammability Rating	UL94-V2
额定电流Rated current	20A
额定电压Rated voltage	600V
螺丝规格Screw specifications	M4
导线截面 Wire Range	0.5-2.5mm ²

产品型号Model	TA-2006
长高Length/width/high(MM)	92.5*34*21
产品材质 Material	PC/黄铜镀锌/铜镀锌
外壳/连接件/螺丝/盖板	AS树脂或者PC聚碳
绝缘阻燃等级	UL94-V2
Insulating Flammability Rating	UL94-V2
额定电流Rated current	20A
额定电压Rated voltage	600V
螺丝规格Screw specifications	M4
导线截面 Wire Range	0.5-2.5mm ²

产品型号Model	TA-2012
长高Length/width/high(MM)	167.5*34*21
产品材质 Material	PC/黄铜镀锌/铜镀锌
外壳/连接件/螺丝/盖板	AS树脂或者PC聚碳
绝缘阻燃等级	UL94-V2
Insulating Flammability Rating	UL94-V2
额定电流Rated current	20A
额定电压Rated voltage	600V
螺丝规格Screw specifications	M4
导线截面 Wire Range	0.5-2.5mm ²

C-16 TBC 固定式系列接线端

C



产品型号Model	TBC-6003
长高Length/width/high(MM)	75*38*32
产品材质 Material	PC/黄铜镀镍/铜镀锌
外壳/连接件/螺丝/盖板	AS树脂或者PC聚碳
绝缘阻燃等级	UL94-V2
额定电流Rated current	60A
额定电压Rated voltage	600V
螺丝规格Screw specifications	M6
导线截面 Wire Range	0.5-10mm ²



产品型号Model	TBC-6004
长高Length/width/high(MM)	92.5*38*32
产品材质 Material	PC/黄铜镀镍/铜镀锌
外壳/连接件/螺丝/盖板	AS树脂或者PC聚碳
绝缘阻燃等级	UL94-V2
额定电流Rated current	60A
额定电压Rated voltage	600V
螺丝规格Screw specifications	M6
导线截面 Wire Range	0.5-10mm ²



产品型号Model	TBC-6005
长高Length/width/high(MM)	111*38*32
产品材质 Material	PC/黄铜镀镍/铜镀锌
外壳/连接件/螺丝/盖板	AS树脂或者PC聚碳
绝缘阻燃等级	UL94-V2
额定电流Rated current	60A
额定电压Rated voltage	600V
螺丝规格Screw specifications	M6
导线截面 Wire Range	0.5-10mm ²



产品型号Model	TBC-6006
长高Length/width/high(MM)	128.5*38*32
产品材质 Material	PC/黄铜镀镍/铜镀锌
外壳/连接件/螺丝/盖板	AS树脂或者PC聚碳
绝缘阻燃等级	UL94-V2
额定电流Rated current	60A
额定电压Rated voltage	600V
螺丝规格Screw specifications	M6
导线截面 Wire Range	0.5-10mm ²

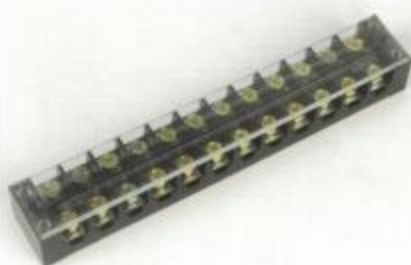

产品型号Model	TBC-6012
长高Length/width/high(MM)	235*38*32
产品材质 Material	PC/黄铜镀镍/铜镀锌
外壳/连接件/螺丝/盖板	AS树脂或者PC聚碳
绝缘阻燃等级	UL94-V2
额定电流Rated current	60A
额定电压Rated voltage	600V
螺丝规格Screw specifications	M6
导线截面 Wire Range	0.5-10mm ²



产品型号Model	TBC-1003
长高Length/width/high(MM)	86.7*43.5*35
产品材质 Material	PC/黄铜镀镍/铜镀锌
外壳/连接件/螺丝/盖板	AS树脂或者PC聚碳
绝缘阻燃等级	UL94-V2
额定电流Rated current	100A
额定电压Rated voltage	600V
螺丝规格Screw specifications	M6
导线截面 Wire Range	0.5-25mm ²

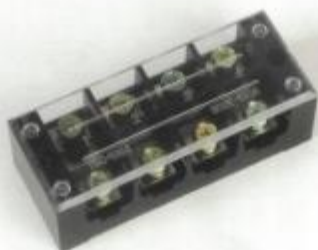

产品型号Model	TBC-1004
长高Length/width/high(MM)	109*43.5*35
产品材质 Material	PC/黄铜镀镍/铜镀锌
外壳/连接件/螺丝/盖板	AS树脂或者PC聚碳
绝缘阻燃等级	UL94-V2
额定电流Rated current	100A
额定电压Rated voltage	600V
螺丝规格Screw specifications	M6
导线截面 Wire Range	0.5-25mm ²

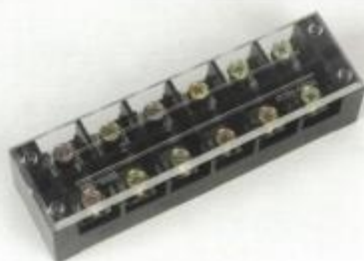

产品型号Model	TBC-1006
长高Length/width/high(MM)	153*43.5*35
产品材质 Material	PC/黄铜镀镍/铜镀锌
外壳/连接件/螺丝/盖板	AS树脂或者PC聚碳
绝缘阻燃等级	UL94-V2
额定电流Rated current	100A
额定电压Rated voltage	600V
螺丝规格Screw specifications	M6
导线截面 Wire Range	0.5-25mm ²

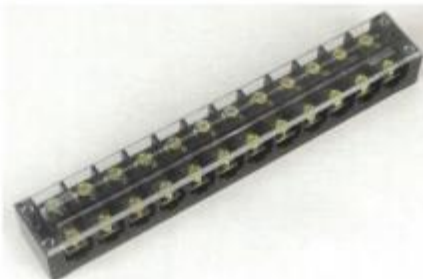

产品型号Model	TBC-10012
长高Length/width/high(MM)	284*43.5*35
产品材质 Material	PC/黄铜镀镍/铜镀锌
外壳/连接件/螺丝/盖板	AS树脂或者PC聚碳
绝缘阻燃等级	UL94-V2
额定电流Rated current	100A
额定电压Rated voltage	600V
螺丝规格Screw specifications	M6
导线截面 Wire Range	0.5-25mm ²

C-17 TD 系列接线端子



产品型号 Model	TD-1510
长高Length/width/high(MM)	116*30.5*31
产品材质 Material	PC/黄铜镀镍/铜镀锌
外壳/连接件/螺丝/盖板	AS树脂或者PC聚碳
绝缘阻燃等级 Insulating Flammability Rating	UL94-V2
额定电流Rated current	15A
额定电压Rated voltage	600V
螺丝规格Screw specifications	M3
导线截面 Wire Range	0.75-1.5mm ²



产品型号 Model	TD-2010
长高Length/width/high(MM)	147*39*38.5
产品材质 Material	PC/黄铜镀镍/铜镀锌
外壳/连接件/螺丝/盖板	AS树脂或者PC聚碳
绝缘阻燃等级 Insulating Flammability Rating	UL94-V2
额定电流Rated current	20A
额定电压Rated voltage	600V
螺丝规格Screw specifications	M4
导线截面 Wire Range	1.5-2.5mm ²



产品型号 Model	TD-3010
长高Length/width/high(MM)	180*43.7*45
产品材质 Material	PC/黄铜镀镍/铜镀锌
外壳/连接件/螺丝/盖板	AS树脂或者PC聚碳
绝缘阻燃等级 Insulating Flammability Rating	UL94-V2
额定电流Rated current	30A
额定电压Rated voltage	600V
螺丝规格Screw specifications	M5
导线截面 Wire Range	2.5-6mm ²



产品型号 Model	TD-6010
长高Length/width/high(MM)	224*52*53
产品材质 Material	PC/黄铜镀镍/铜镀锌
外壳/连接件/螺丝/盖板	AS树脂或者PC聚碳
绝缘阻燃等级 Insulating Flammability Rating	UL94-V2
额定电流Rated current	60A
额定电压Rated voltage	600V
螺丝规格Screw specifications	M5
导线截面 Wire Range	4-10mm ²

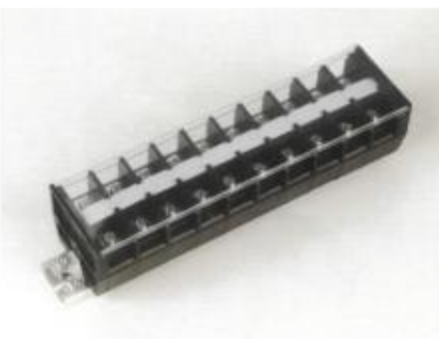

产品型号 Model	TD-10010
长高Length/width/high(MM)	260*60*50
产品材质 Material	PC/黄铜镀镍/铜镀锌
外壳/连接件/螺丝/盖板	AS树脂或者PC聚碳
绝缘阻燃等级 Insulating Flammability Rating	UL94-V2
额定电流Rated current	100A
额定电压Rated voltage	600V
螺丝规格Screw specifications	M6
导线截面 Wire Range	10-25mm ²

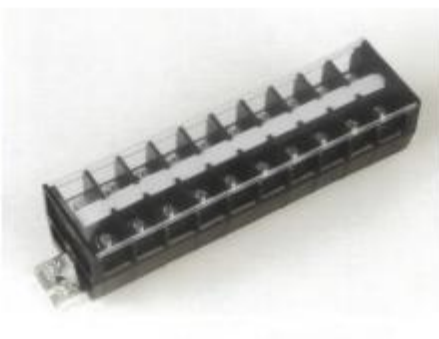

产品型号 Model	TD-15010/20010
长高Length/width/high(MM)	266*65*50
产品材质 Material	PC/黄铜镀镍/铜镀锌
外壳/连接件/螺丝/盖板	AS树脂或者PC聚碳
绝缘阻燃等级 Insulating Flammability Rating	UL94-V2
额定电流Rated current	150/200A
额定电压Rated voltage	600V
螺丝规格Screw specifications	M8
导线截面 Wire Range	25-35mm ²

C-18 TC 系列大电流接线端子

C



产品型号Model	TC-602
长高Length/width/high(MM)	58*42.4*35
产品材质 Material	PC/黄铜镀镍/钢镀锌
外壳/连接件/螺丝/盖板	AS树脂或者PC聚碳
绝缘阻燃等级 Insulating Flammability Rating	UL94-V2
额定电流Rated current	60A
额定电压Rated voltage	600V
螺丝规格Screw specifications	M6
导线截面 Wire Range	6-14mm ²



产品型号Model	TC-603
长高Length/width/high(MM)	86.7*43*33.5
产品材质 Material	PC/黄铜镀镍/钢镀锌
外壳/连接件/螺丝/盖板	AS树脂或者PC聚碳
绝缘阻燃等级 Insulating Flammability Rating	UL94-V2
额定电流Rated current	60A
额定电压Rated voltage	600V
螺丝规格Screw specifications	M6
导线截面Conductor cross	6-14mm ²



产品型号Model	TC-604
长高Length/width/high(MM)	116*43*33.5
产品材质 Material	PC/黄铜镀镍/钢镀锌
外壳/连接件/螺丝/盖板	AS树脂或者PC聚碳
绝缘阻燃等级 Insulating Flammability Rating	UL94-V2
额定电流Rated current	60A
额定电压Rated voltage	600V
螺丝规格Screw specifications	M6
导线截面Conductor cross	6-14mm ²



产品型号Model	TC-1002
长高Length/width/high(MM)	69.3*54.4*39
产品材质 Material	PC/黄铜镀镍/钢镀锌
外壳/连接件/螺丝/盖板	AS树脂或者PC聚碳
绝缘阻燃等级 Insulating Flammability Rating	UL94-V2
额定电流Rated current	100A
额定电压Rated voltage	600V
螺丝规格Screw specifications	M6
导线截面 Wire Range	10-22mm ²



产品型号Model	TC-1003
长高Length/width/high(MM)	106*54.5*37.5
产品材质 Material	PC/黄铜镀镍/钢镀锌
外壳/连接件/螺丝/盖板	AS树脂或者PC聚碳
绝缘阻燃等级 Insulating Flammability Rating	UL94-V2
额定电流Rated current	100A
额定电压Rated voltage	600V
螺丝规格Screw specifications	M6
导线截面 Wire Range	10-22mm ²



产品型号Model	TC-1004
长高Length/width/high(MM)	140*54.5*37.5
产品材质 Material	PC/黄铜镀镍/钢镀锌
外壳/连接件/螺丝/盖板	AS树脂或者PC聚碳
绝缘阻燃等级 Insulating Flammability Rating	UL94-V2
额定电流Rated current	100A
额定电压Rated voltage	600V
螺丝规格Screw specifications	M6
导线截面 Wire Range	10-22mm ²



产品型号Model	TC-1503
长高Length/width/high(MM)	115*56.3*40
产品材质 Material	PC/黄铜镀镍/钢镀锌
外壳/连接件/螺丝/盖板	AS树脂或者PC聚碳
绝缘阻燃等级 Insulating Flammability Rating	UL94-V2
额定电流Rated current	150A
额定电压Rated voltage	600V
螺丝规格Screw specifications	M8
导线截面 Wire Range	40-60mm ²



产品型号Model	TC-1504
长高Length/width/high(MM)	152*66.3*40
产品材质 Material	PC/黄铜镀镍/钢镀锌
外壳/连接件/螺丝/盖板	AS树脂或者PC聚碳
绝缘阻燃等级 Insulating Flammability Rating	UL94-V2
额定电流Rated current	150A
额定电压Rated voltage	600V
螺丝规格Screw specifications	M8
导线截面 Wire Range	40-60mm ²



产品型号Model	TC-2003
长高Length/width/high(MM)	132*72*45
产品材质 Material	PC/黄铜镀镍/钢镀锌
外壳/连接件/螺丝/盖板	AS树脂或者PC聚碳
绝缘阻燃等级 Insulating Flammability Rating	UL94-V2
额定电流Rated current	150A
额定电压Rated voltage	600V
螺丝规格Screw specifications	M8
导线截面 Wire Range	60-100mm ²

C-18 TC 系列大电流接线端子

C



产品型号Model	TC-2004
长高Length/width/high(MM)	176*73*45
产品材质 Material	PC/黄铜镀镍/铜镀锌
外壳/连接件/螺丝/盖板	AS树脂或者PC聚碳
绝缘阻燃等级	UL94-V2
Insulating Flammability Rating	UL94-V2
额定电流Rated current	200A
额定电压Rated voltage	600V
螺丝规格Screw specifications	M8
导线截面 Wire Range	60-100mm ²



产品型号Model	TC-3003
长高Length/width/high(MM)	166*90*52
产品材质 Material	PC/黄铜镀镍/铜镀锌
外壳/连接件/螺丝/盖板	AS树脂或者PC聚碳
绝缘阻燃等级	UL94-V2
Insulating Flammability Rating	UL94-V2
额定电流Rated current	300A
额定电压Rated voltage	600V
螺丝规格Screw specifications	M10
导线截面 Wire Range	100-150mm ²



产品型号Model	TC-3004
长高Length/width/high(MM)	220*90*52
产品材质 Material	PC/黄铜镀镍/铜镀锌
外壳/连接件/螺丝/盖板	AS树脂或者PC聚碳
绝缘阻燃等级	UL94-V2
Insulating Flammability Rating	UL94-V2
额定电流Rated current	300A
额定电压Rated voltage	600V
螺丝规格Screw specifications	M10
导线截面 Wire Range	100-150mm ²



产品型号Model	TC-4003
长高Length/width/high(MM)	165*90*52
产品材质 Material	PC/黄铜镀镍/铜镀锌
外壳/连接件/螺丝/盖板	AS树脂或者PC聚碳
绝缘阻燃等级	UL94-V2
Insulating Flammability Rating	UL94-V2
额定电流Rated current	400A
额定电压Rated voltage	600V
螺丝规格Screw specifications	M10
导线截面 Wire Range	100-150mm ²



产品型号Model	TC-4004
长高Length/width/high(MM)	220*90*52
产品材质 Material	PC/黄铜镀镍/铜镀锌
外壳/连接件/螺丝/盖板	AS树脂或者PC聚碳
绝缘阻燃等级	UL94-V2
Insulating Flammability Rating	UL94-V2
额定电流Rated current	400A
额定电压Rated voltage	600V
螺丝规格Screw specifications	M10
导线截面 Wire Range	100-150mm ²



产品型号Model	TC-6003
长高Length/width/high(MM)	205*74*100
产品材质 Material	PC/黄铜镀镍/铜镀锌
外壳/连接件/螺丝/盖板	AS树脂或者PC聚碳
绝缘阻燃等级	UL94-V2
Insulating Flammability Rating	UL94-V2
额定电流Rated current	600A
额定电压Rated voltage	600V
螺丝规格Screw specifications	M12
导线截面 Wire Range	200-400mm ²



产品型号Model	TC-6004
长高Length/width/high(MM)	275*74*100
产品材质 Material	PC/黄铜镀镍/铜镀锌
外壳/连接件/螺丝/盖板	AS树脂或者PC聚碳
绝缘阻燃等级	UL94-V2
Insulating Flammability Rating	UL94-V2
额定电流Rated current	600A
额定电压Rated voltage	600V
螺丝规格Screw specifications	M12
导线截面 Wire Range	200-400mm ²

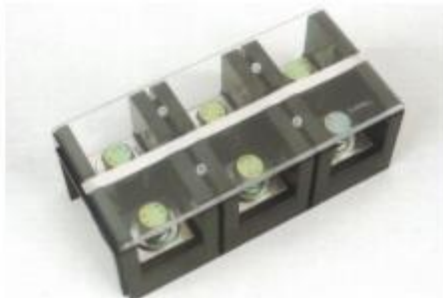

产品型号Model	TC-10003
长高Length/width/high(MM)	236*114*85.2
产品材质 Material	PC/黄铜镀镍/铜镀锌
外壳/连接件/螺丝/盖板	AS树脂或者PC聚碳
绝缘阻燃等级	UL94-V2
Insulating Flammability Rating	UL94-V2
额定电流Rated current	1000A
额定电压Rated voltage	600V
螺丝规格Screw specifications	M12
导线截面 Wire Range	300-500mm ²

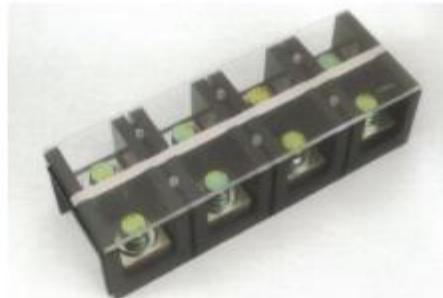

产品型号Model	TC-10004
长高Length/width/high(MM)	315*114*85.2
产品材质 Material	PC/黄铜镀镍/铜镀锌
外壳/连接件/螺丝/盖板	AS树脂或者PC聚碳
绝缘阻燃等级	UL94-V2
Insulating Flammability Rating	UL94-V2
额定电流Rated current	1000A
额定电压Rated voltage	600V
螺丝规格Screw specifications	M12
导线截面 Wire Range	300-500mm ²

C-19 短接片系列

C

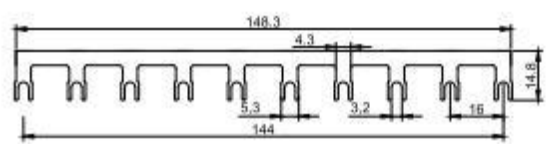
	产品名称 Name	继电器短接片	尺寸 Size
	产品型号 Model	DLP-16 (10节)	
	长宽 Length/width(MM)	148.3*14.8	
	产品材质 Material	PVC+黄铜镀锡	
	绝缘阻燃等级 Insulating Flammability Rating	UL94-V2	

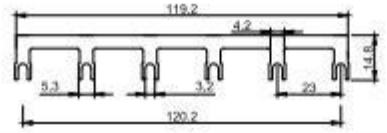
	产品名称 Name	继电器短接片	尺寸 Size
	产品型号 Model	DLP08A-23 (6节)	
	长宽 Length/width(MM)	119.2*14.8	
	产品材质 Material	PVC+黄铜镀锡	
	绝缘阻燃等级 Insulating Flammability Rating	UL94-V2	

	产品名称 Name	继电器短接片	尺寸 Size
	产品型号 Model	DLP14A-29.6 (8节)	
	长宽 Length/width(MM)	211.5*14.8	
	产品材质 Material	PVC+黄铜镀锡	
	绝缘阻燃等级 Insulating Flammability Rating	UL94-V2	

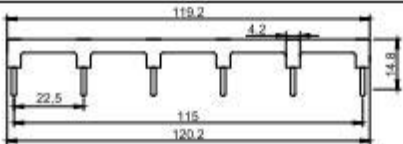
	产品名称 Name	继电器短接片	尺寸 Size
	产品型号 Model	DLP08A-22.5	
	长宽 Length/width(MM)	119.2*14.8	
	产品材质 Material	PVC+黄铜镀锡	
	绝缘阻燃等级 Insulating Flammability Rating	UL94-V2	

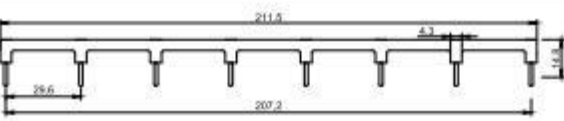
	产品名称 Name	继电器短接片	尺寸 Size
	产品型号 Model	DLP14A-29.6	
	长宽 Length/width(MM)	211.5*14.8	
	产品材质 Material	PVC+黄铜镀锡	
	绝缘阻燃等级 Insulating Flammability Rating	UL94-V2	

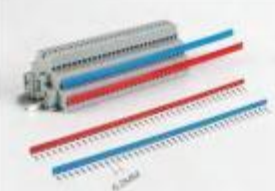
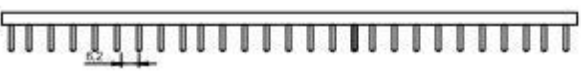
	产品名称 Name	三层端子边插	尺寸 Size
	产品型号 Model	DLP-DIKD1.5	
	长宽 Length/width(MM)	—	
	产品材质 Material	PVC+黄铜镀锡	
	绝缘阻燃等级 Insulating Flammability Rating	UL94-V2	

	产品名称 Name	短接片	尺寸 Size
	产品型号 Model	DLP-1512	
	长宽 Length/width(MM)	99.95*20	
	产品材质 Material	PVC+黄铜镀锡	
	绝缘阻燃等级 Insulating Flammability Rating	UL94-V2	

C-19 短接片系列

C



产品名称 Name	短接片	尺寸 Size
产品型号 Model	DLP-2512	
长宽 Length/width (MM)	137.1*23	
产品材质 Material	PVC+黄铜镀锡	
绝缘阻燃等级 Insulating Flammability Rating	UL94-V2	



产品名称 Name	短接片	尺寸 Size
产品型号 Model	DLP-1510	
长宽 Length/width (MM)	75.4*20.5	
产品材质 Material	PVC+黄铜镀锡	
绝缘阻燃等级 Insulating Flammability Rating	UL94-V2	



产品名称 Name	短接片	尺寸 Size
产品型号 Model	DLP-2010	
长宽 Length/width (MM)	102.1*20	
产品材质 Material	PVC+黄铜镀锡	
绝缘阻燃等级 Insulating Flammability Rating	UL94-V2	



产品名称 Name	短接片	尺寸 Size
产品型号 Model	DLP-TBR-10A DLP-TBC-10A	
长宽 Length/width (MM)	84.5*20	
产品材质 Material	PVC+黄铜镀锡	
绝缘阻燃等级 Insulating Flammability Rating	UL94-V2	



产品名称 Name	短接片	尺寸 Size
产品型号 Model	DLP-TBR-20A DLP-TBC-20A	
长宽 Length/width (MM)	102*21	
产品材质 Material	PVC+黄铜镀锡	
绝缘阻燃等级 Insulating Flammability Rating	UL94-V2	



产品名称 Name	短接片	尺寸 Size
产品型号 Model	DLP-TBD-10A DLP-TB1510 (10节)	
长宽 Length/width (MM)	82.45*20	
产品材质 Material	PVC+黄铜镀锡	
绝缘阻燃等级 Insulating Flammability Rating	UL94-V2	

C-19 短接片系列

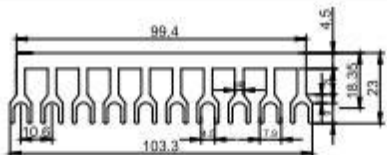
	产品名称 Name	短接片	
	产品型号 Model	DLP-TBD-20A (10节)	
	长宽 Length/width (MM)	99.4*23	
	产品材质 Material	PVC+黄铜镀锡	
	绝缘阻燃等级 Insulating Flammability Rating	UL94-V2	

	产品名称 Name	短接片	
	产品型号 Model	DLP-RBR-30A DLP-TBC-30A DLP-TD 3010(10节)	
	长宽 Length/width (MM)	124.6*23	
	产品材质 Material	PVC+黄铜镀锡	
	绝缘阻燃等级 Insulating Flammability Rating	UL94-V2	

	产品名称 Name	立体短接片	
	产品型号 Model	DLP-NHT-53-12 DLP-TB1512	
	长宽 Length/width (MM)	99.95*20	
	产品材质 Material	PVC+黄铜镀锡	
	绝缘阻燃等级 Insulating Flammability Rating	UL94-V2	

	产品名称 Name	立体短接片	
	产品型号 Model	DLP-TBD-2012	
	长宽 Length/width (MM)	99.4*23	
	产品材质 Material	PVC+黄铜镀锡	
	绝缘阻燃等级 Insulating Flammability Rating	UL94-V2	

C-20 TBC/TBR/TBD防尘盖板

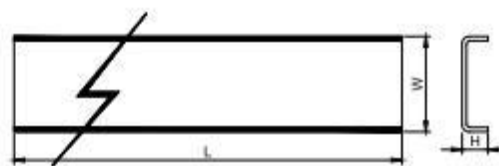
产品材质 Material	聚碳酸酯(PCI)	型号 Item	长L(m)	宽W(mm)	高H(mm)
绝缘阻燃等级 Insulating Flammability Rating	UL94-V2	G-TBC-10A	1米	30	5
备注 Mark	适配PC/黄铜镀锡/铜镀锌/树脂	G-TBC-20A	1米	33.2	5
		G-TBC-30A	1米	33.2	5
		G-TBC-60A	1米	51.3	5
		G-TBR-10A	1米	30	5
		G-TBR-20A	1米	33.2	5
		G-TBR-30A	1米	33.2	5
		G-TBD-10A	1米	30	5
		G-TBD-20A	1米	33.2	5

C-21 快速接线端子

单排



产品名称 Name	单排快速端子
材质 Material	壳体尼龙/手柄PC 弹簧片进口301不锈钢 联络件: 紫铜
颜色 Color	壳体灰色/手柄橙色
绝缘阻燃等级 Insulating Flammability Rating	UL94-V0
温度范围 Temperature wires	-25°C~95°C
额定电流 Rated current	32A
额定电压 Rated voltage	250V AC/DC
导线截面 Conductor cross section	0.2-4mm ²
美国线规 A.W.G.	28-14
接触电阻 Contact resistance	≤0.015Ω
绝缘电阻 Insulation resistance	≥1000mΩ



产品型号 Model	WQC222-412	WQC222-413	WQC222-414	WQC222-415	WQC222-418
长宽高 L/W/H(MM)	12.5*20.5*14.5	17.3*20.5*14.5	21.9*20.5*14.5	26.5*20.5*14.5	40*20.5*14.5

双排

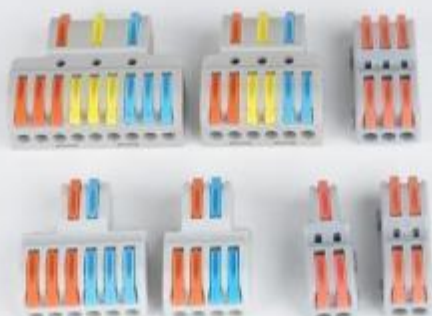

产品名称 Name	双排快速端子
材质 Material	壳体尼龙/手柄PC 弹簧片进口301不锈钢 联络件: 紫铜
颜色 Color	壳体灰色/手柄橙色 壳体灰色/手柄多色
绝缘阻燃等级	UL94-V0
温度范围 Temperature wires	-25°C~95°C
额定电流 Rated current	32A
额定电压 Rated voltage	250V-600V
导线截面 Conductor cross section	0.2-4mm ²
美国线规 A.W.G.	28-12
接触电阻 Contact resistance	≤0.015Ω
绝缘电阻 Insulation resistance	≥1000mΩ

C-21 快速接线端子



产品型号 Model	WQC121	WQC211	WQC212	WQC313
长宽高 L/W/H(MM)	导轨式: 43*30.8*8.2	拼接式: 9*39.2*14.5	对接式: 13.6*39.2*14.5 螺钉式: 25.6*39.2*14.5	对接式: 18.5*39.2*14.5 螺钉式: 30.5*39.2*14.5



产品型号 Model	WQC223B-4P	WQC223B-5P	WQC223B-6P	WQC223B-8P
长宽高 L/W/H(MM)	对接式: 23.5*39.2*14.5 螺钉式: 35.5*39.2*14.5	对接式: 28.5*39.2*14.5 螺钉式: 40.5*39.2*14.5	对接式: 33.5*39.2*14.5 螺钉式: 45.5*39.2*14.5	对接式: 43.5*39.2*14.5 螺钉式: 55.5*39.2*14.5

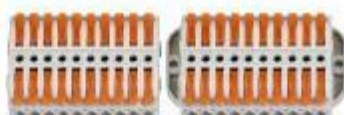

产品型号 Model	WQC223B-10P	WQC223B-12P	WQC223B-14P
长宽高 L/W/H(MM)	对接式: 53.5*39.2*14.5 螺钉式: 65.5*39.2*14.5	对接式: 63.5*39.2*14.5 螺钉式: 75.5*39.2*14.5	对接式: 73.5*39.2*14.5 螺钉式: 85.5*39.2*14.5



产品型号 Model	WQC223B-16P	WQC223B-18P
长宽高 L/W/H(MM)	对接式: 83.5*39.2*14.5 螺钉式: 95.5*39.2*14.5	对接式: 93.5*39.2*14.5 螺钉式: 105.5*39.2*14.5



产品型号 Model	WQC223B-20P	WQC223B-22P
长宽高 L/W/H(MM)	对接式: 103.5*39.2*14.5 螺钉式: 115.5*39.2*14.5	对接式: 113.5*39.2*14.5 螺钉式: 125.5*39.2*14.5

C-21 快速接线端子



产品型号 Model	WQC223B-24P	WQC223B-26P
长宽高 L/W/H(MM)	对接式: 123.5*39.2*14.5 螺钉式: 135.5*39.2*14.5	对接式: 133.5*39.2*14.5 螺钉式: 145.5*39.2*14.5



产品型号 Model	WQC223B-28P	WQC223B-30P
长宽高 L/W/H(MM)	对接式: 143.5*39.2*14.5 螺钉式: 155.5*39.2*14.5	对接式: 153.5*39.2*14.5 螺钉式: 165.5*39.2*14.5



产品型号 Model	WQC223B32P	WQC223B-34P
长宽高 L/W/H(MM)	对接式: 163.5*39.2*14.5 螺钉式: 175.5*39.2*14.5	对接式: 173.5*39.2*14.5 螺钉式: 185.5*39.2*14.5



产品型号 Model	WQC223B-36P	WQC223B-38P
长宽高 L/W/H(MM)	对接式: 183.5*39.2*14.5 螺钉式: 195.5*39.2*14.5	对接式: 193.5*39.2*14.5 螺钉式: 205.5*39.2*14.5

少进多出
特殊式

产品名称 Name	少进多出快速端子
材质 Material	壳体尼龙/手柄PC 弹簧片进口301不锈钢 联络件: 紫铜
颜色 Color	壳体灰色/手柄橙色 黄色 蓝色
绝缘阻燃等级 Insulating Flammability Rating	UL94-V0
温度范围 Temperature wires	-25°C~95°C
额定电流 Rated current	32A
额定电压 Rated voltage	250V~600V
导线截面 Conductor cross section	0.5-4mm ²
美国线规 A.W.G.	28-12
接触电阻 Contact resisttance	≤0.015Ω
绝缘电阻 Insulation resistance	≥1000mΩ

C-21 快速接线端子



产品型号 Model	2进4出	2进6出	2进8出	2进10出
长宽高L/W/H(MM)	23.5*41.4*14.5	33.5*41.4*14.5	43.5*38.4*15.6	53.5*38.4*15.6



产品型号 Model	3进6出	3进9出	3进12出	3进15出
长宽高L/W/H(MM)	35.9*41.4*14.5	48.5*41.4*14.5	63.5*38.4*15.6	78.5*38.4*15.6



产品型号 Model	4进8出	4进12出	产品型号 Model	导轨式2进8出	导轨式2进10出
长宽高L/W/H(MM)	51.3*38.4*15.6	71.3*38.4*15.6	长宽高L/W/H(MM)	46.3*43.7*32.7	53.5*43.7*32.7



产品型号 Model	导轨式3进12出	导轨式3进15出	产品型号 Model	导轨式4进8出	导轨式4进12出
长宽高L/W/H(MM)	66.3*43.7*32.7	78.5*43.7*32.7	长宽高L/W/H(MM)	43.5*38.4*32.7	71.3*38.4*32.7



产品型号 Model	T3	T4
长宽高L/W/H(MM)	38.3*23.8*14.5	38.3*23.8*14.5

C-21 快速接线端子

双排



产品名称 Name	双排快速端子
材质 Material	壳体尼龙/手柄PC
颜色 Color	壳体灰色/手柄橙色/蓝色
绝缘阻燃等级 Insulating Flammability Rating	UL94-V2 (UL94-V0可定制)
温度范围 Temperature wires	-25°C-95°C
额定电流 Rated current	32A
额定电压 Rated voltage	300V/600V
导线截面 Wire Range	0.2-4mm ²
美国线规 A.W.G.	20-10
线数范围 Pole	9mm
剥线长度 Stripping length	13mm



产品型号 Model	WQK226A2/WQK226B2	WQK226A3/WQK226B3	WQK226A4/WQK226B4
长宽高L/W/H(MM)	对接式: 39*13.5*15.5 螺钉式: 39*13.5*27.5	对接式: 39*13.5*22 螺钉式: 39*13.5*34	对接式: 39*13.5*28.5 螺钉式: 39*13.5*40.5



产品型号 Model	WQK226A5/WQK226B5	WQK226A6/WQK226B6	WQK226A6/WQK226B6
长宽高L/W/H(MM)	对接式: 39*13.5*35 螺钉式: 39*13.5*47	对接式: 39*13.5*41.5 螺钉式: 39*13.5*53.5	对接式: 39*13.5*41.5 螺钉式: 39*13.5*53.5



产品型号 Model	WQK226A7	WQK226A8	WQK226A9
长宽高L/W/H(MM)	对接式: 39*13.5*48	对接式: 39*13.5*54.5	对接式: 39*13.5*61



产品型号 Model	WQK226A10	WQK226A11	WQK226A12
长宽高L/W/H(MM)	对接式: 39*13.5*67.5	对接式: 39*13.5*74	对接式: 39*13.5*80.5

C-21 快速接线端子



产品名称 Name	4平方快速端子
材质 Material	壳体PC / 手柄尼龙
颜色 Color	壳体透明/手柄橙色
绝缘阻燃等级 Insulating Flammability Rating	UL94-V2 (UL94-V0可定制)
温度范围 Temperature wires	-25°C-95°C
额定电流 Rated current	32A
额定电压 Rated voltage	250V/600V
导线截面 Wire Range	0.2-4mm ²
美国线规 A.W.G.	24-12
接触电阻 Contact resistance	≤0.015Ω
绝缘电阻 Insulation resistance	≥1000mΩ



产品型号 Model	WQC211-412	WQC211-413	WQC211-414	WQC211-415
长宽高L/W/H(MM)	13*18*10	18*18*10	24.3*18*10	30*18*10



产品名称 Name	6平方快速端子
材质 Material	壳体PC / 手柄尼龙
颜色 Color	壳体透明/手柄橙色
绝缘阻燃等级 Insulating Flammability Rating	UL94-V2 (UL94-V0可定制)
温度范围 Temperature wires	-40°C-105°C
额定电流 Rated current	41A
额定电压 Rated voltage	450V
导线截面 Wire Range	0.5-4mm ² 0.5-6mm ²
美国线规 A.W.G.	20-10
线数范围 Pole	2-5P
剥线长度 Stripping length	10-12mm



产品型号 Model	WQC221-612	WQC221-613	WQC221-614	WQC221-615
长宽高L/W/H(MM)	15.5*21.5*10	22*21.5*10	28.5*21.5*10	35*21.5*10

C22 电度表用接线端子

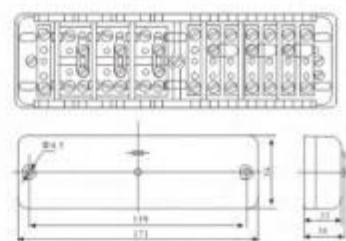
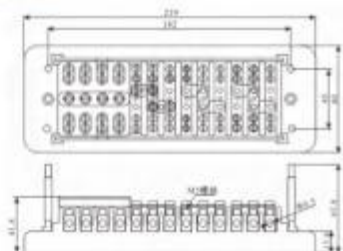

产品型号 Model	WDB-1
材质 Material	AS树脂或者PC聚碳
颜色 Color	如图
绝缘阻燃等级 Insulating Flammability Rating	UL94-V2
孔径 Diameter (mm)	6.5
开孔尺寸 Hole size (mm)	182*45
外形尺寸 Overall dimensions (mm)	219*80*41.8
额定电流 Rated current	40A
额定电压 Rated voltage	500V
导线截面 Wire Range	2.5-6mm ²

产品型号 Model	WDB-2
材质 Material	AS树脂或者PC聚碳
颜色 Color	如图
绝缘阻燃等级 Insulating Flammability Rating	UL94-V2
防护等级 Protection degree	IP30
温度范围 Temperature wires	-40°C-80°C
外形尺寸 Overall dimensions (mm)	171*54*38
主线电流 Main current	25A
支线电流 Branch current	5A
额定电压 Rated voltage	400V

C-23 接线盒系列

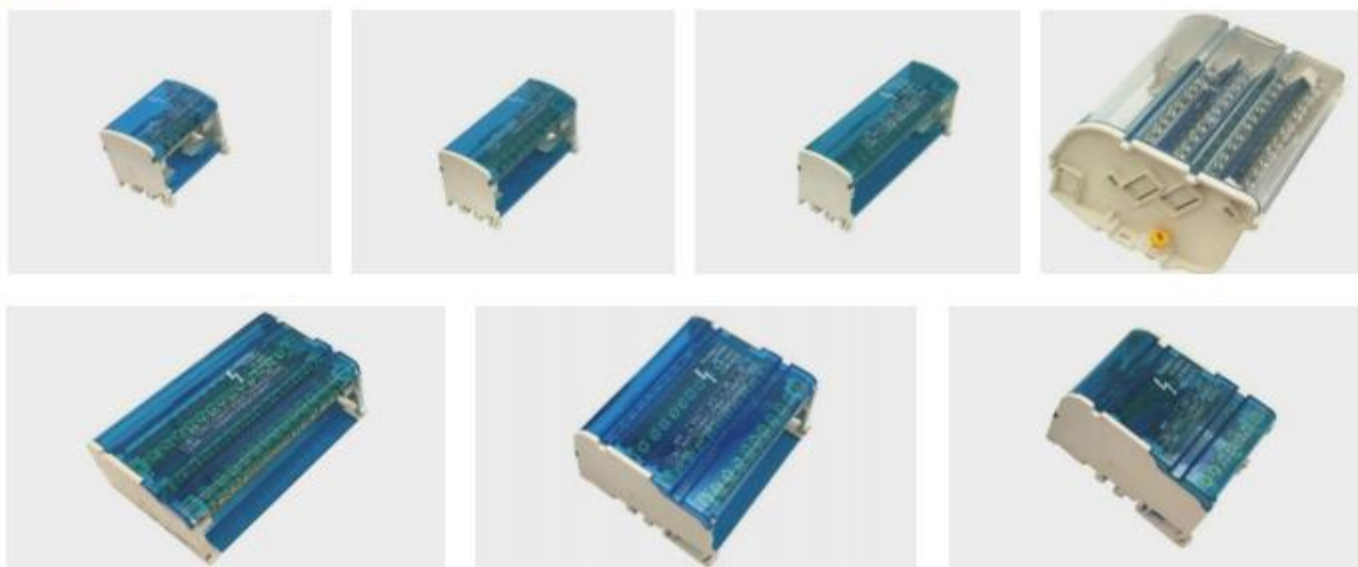

型号	规格	安装尺寸mm(L ²)	外形尺寸	铜件横截面积(mm ²)
WB013 (接线盒)	2x7	45x4	66x45x51	6.5x12
	2x11	80x4	100x45x51	6.5x12
	2x15	112x4	133x45x51	6.5x12
	4x7	45x4	66x88x51	6.5x12
	4x11	80x4	100x88x51	6.5x12
	4x15	112x4	133x88x51	6.5x12
	4x13(160A)	165x4	180x73x138	8x17



型号	规格	安装尺寸mm (L ²)	外形尺寸
WB015 单极分线盒	80A	35x7.5	30x69x49
	125A	35x7.5	29x77x46
	160A	35x7.5	29x77x46
	250A	35x7.5	47x96x50
	400A	35x7.5	47x96x50
	500A	35x7.5	49x96x50



线槽 | 智能照明灯 | 冷压端子 | 端子台 | 导轨 | 管件接头 | 地零排 | 绝缘母线夹 | 拖链 | 结束带
 编织网管 | 热缩管 | Pu气管 | 扣件保护 | 标识类 | 航空插头 | 重载连接器 | 工具系列 | 风机系列

Wenbuluo

江苏稳不落配线器材有限公司
 Wenbuluo Electrical Co., Ltd

☎ 0512-36602880

🌐 www.wenbuluo.com www.wenbuluo.cn

📍 江苏省苏州市昆山市开发区熊庄路25号