

航空插头系列

为中大型智能装备制造企业提供一站式配电器材解决方案

Wenbuluo

2026 V.1.0



P



航空插头系列



P-01
M8组合式航空插头



P-02
M8注塑式航空插头



P-03
M8法兰座



P-04
M12组合式航空插头



P-05
M12注塑式航空插头



P-06
M12法兰座



P-07
M8/M12金属组合式航空插头



P-08
T/Y型航空插头



P-09
7/8"航空插头



P-10
IO-Link

P-01 M12 插头编码定义 Plug Code definition

M12 插头编码定义 Plug Code definition

A-Code

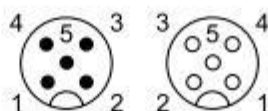
插针
Male插孔
Female

B-Code

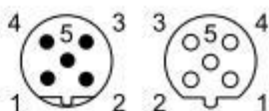
插针
Male插孔
Female

D-Code

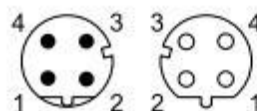
插针
Male插孔
Female

X-Code

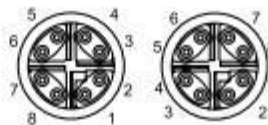
插针
Male插孔
Female

S-Code

插针
Male插孔
Female

T-Code

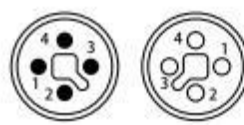
插针
Male插孔
Female

M12 插头编码定义 Plug Code definition

L-Code

插针
Male插孔
Female

K-Code

插针
Male插孔
Female

我们能根据您的实际需求定制电缆长度，如：您需要 0.5m, 1.8m 或者 2.5m 的长度，可在型号最后一部分写进相应的电缆长度，单位：cm

The resulting article number also is the ordering number for your round plug connector. If you also need 0.5 m, 1.8 m or 2.5 m length of this part you just adjust the last 4 digits of the article number. Unit:cm

P-01 连接器定义形式 CONNECTOR DEFINITION FORM

单端预铸线束规格定义 With open ended wires

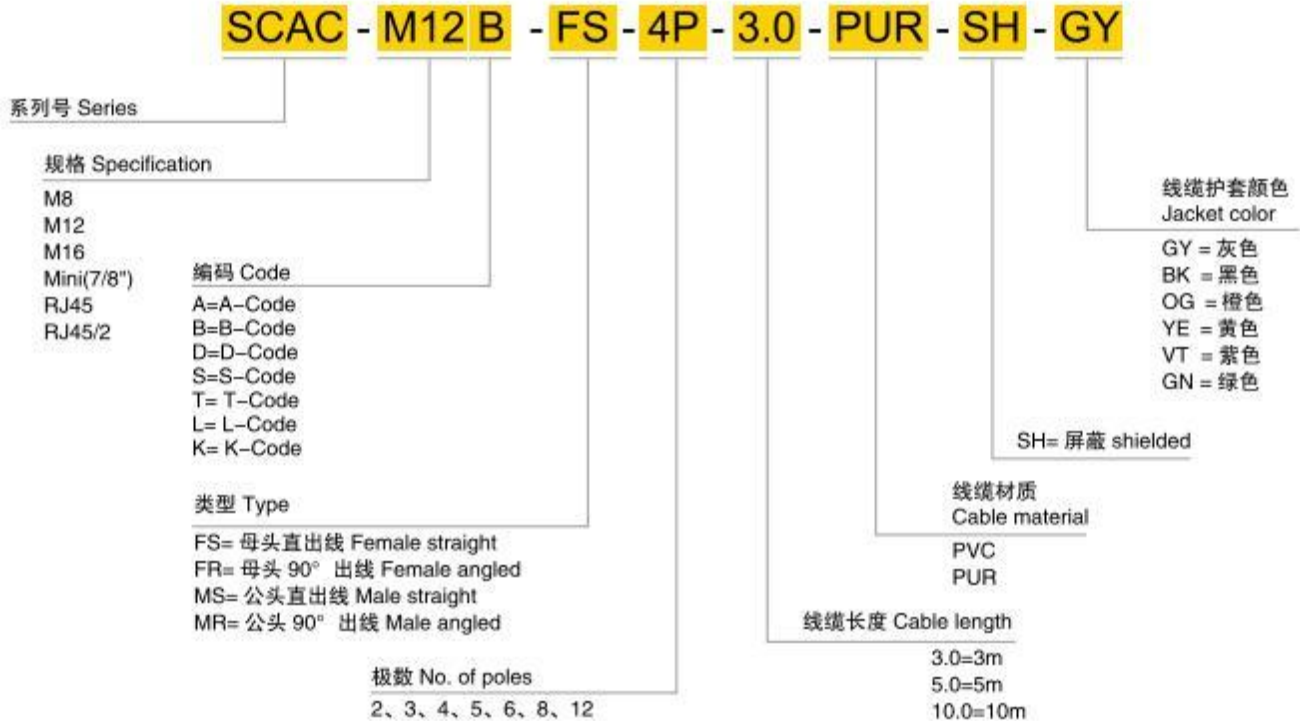

双端预铸线束规格定义 Connection cable

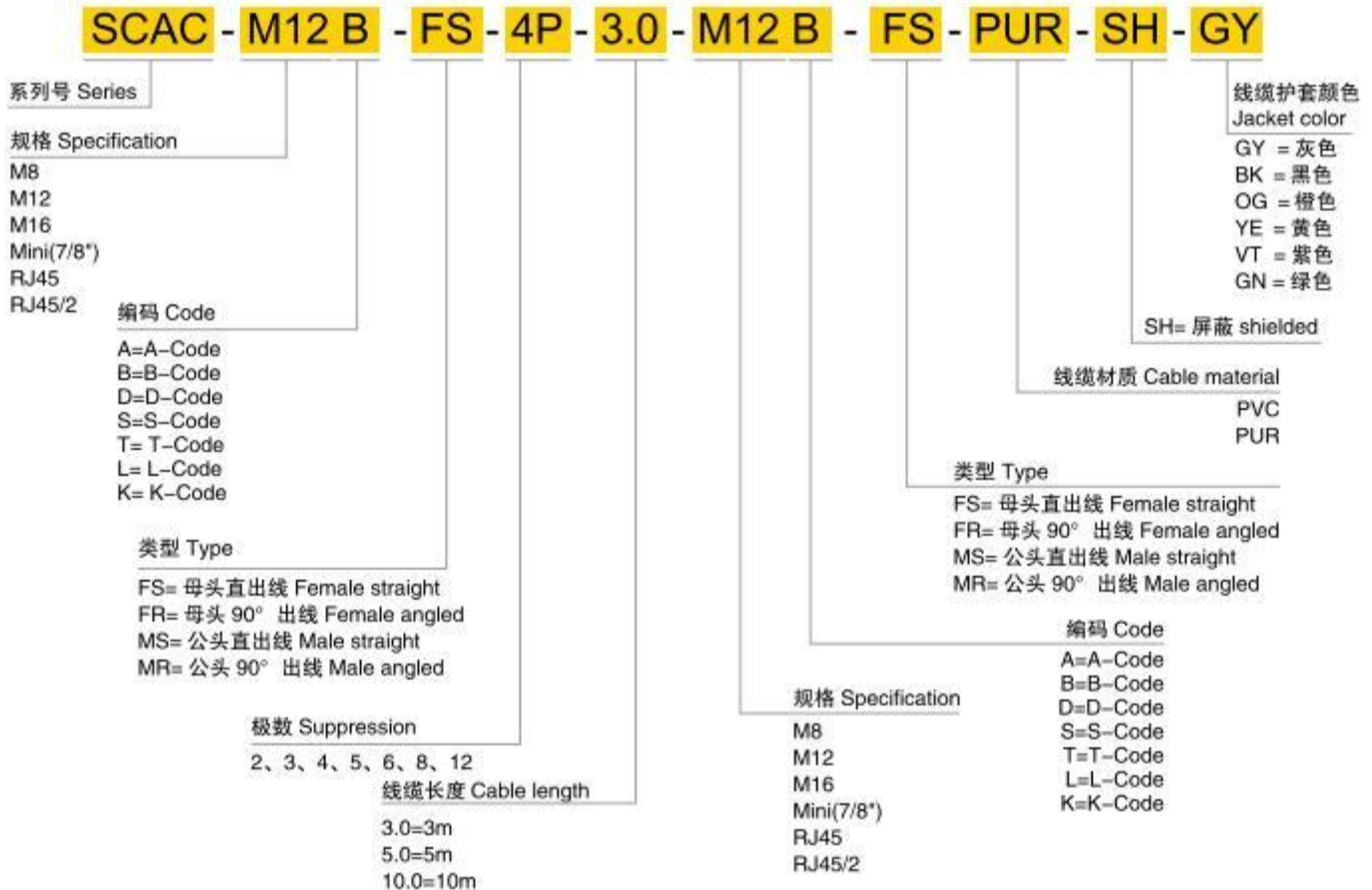

P-01 连接器定义形式 CONNECTOR DEFINITION FORM

现场接线连接器型号定义 Plug connectors for fieldbus technology

P

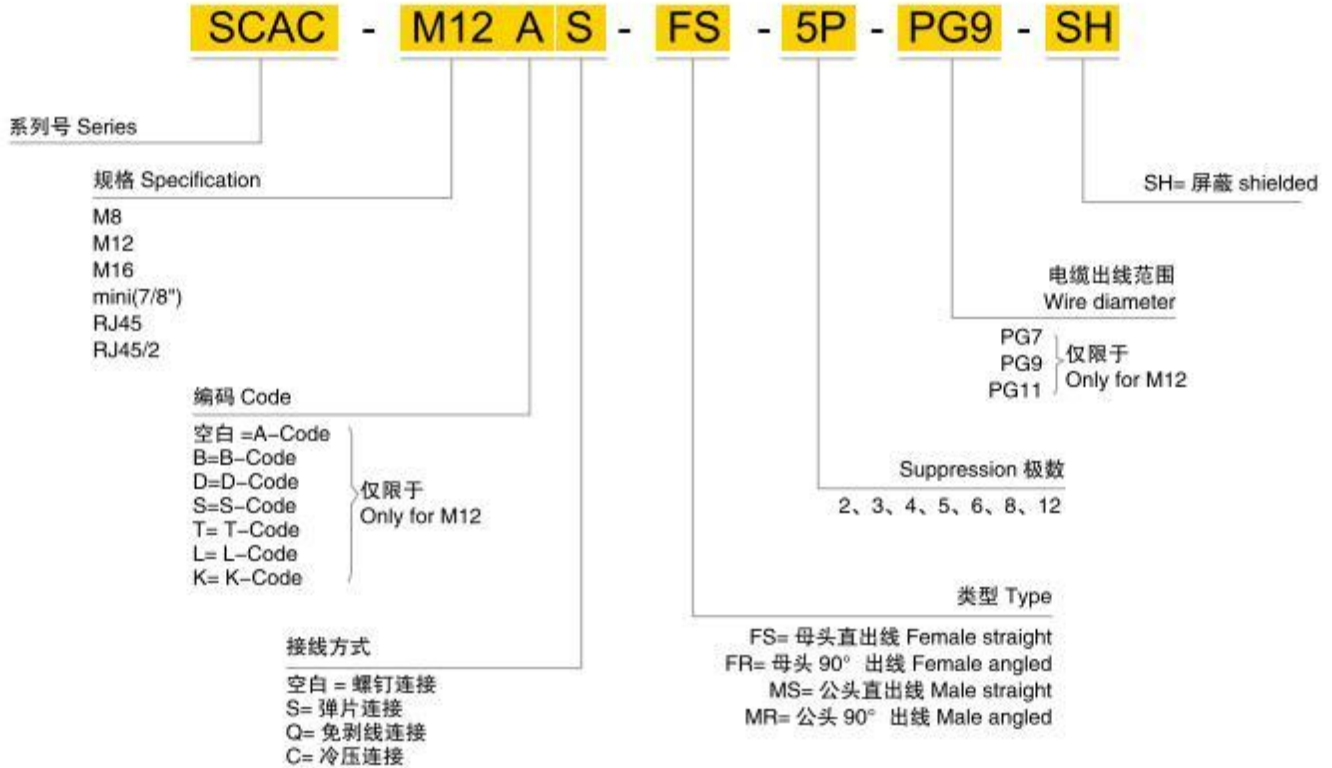

板面安装插座型号定义 Panel installed connectors

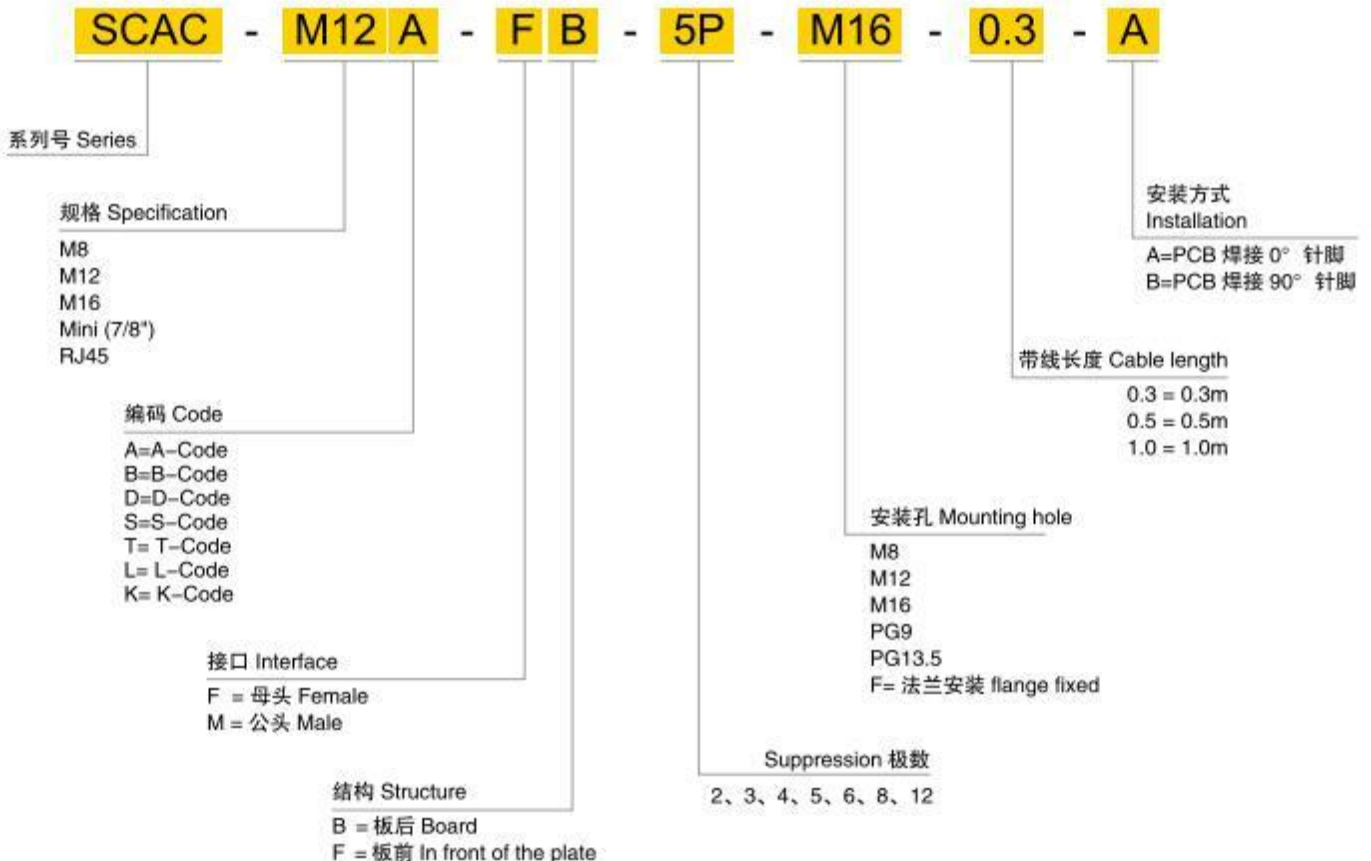

P-01 连接器技术参数 TECHNICAL DATA FOR PLUG CONNECTORS

M8 圆形连接器 直出线 Round plug connector straight / 90°

插针 Male 直出 Straight

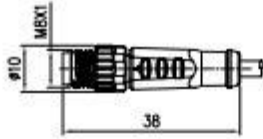

插针 Male 90°

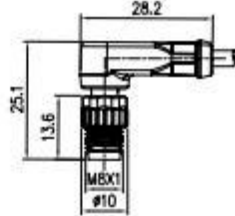

插孔 Female 直出 Straight

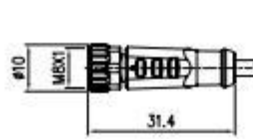

插孔 Female 90°

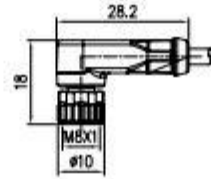

插针 Male 直出 Straight 屏蔽 Shielded

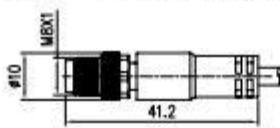

插针 Male 90° 屏蔽 Shielded

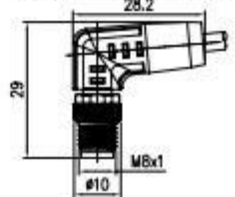

插孔 Female 直出 Straight 屏蔽 Shielded

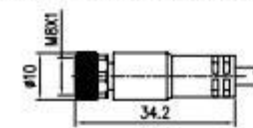

插孔 Female 90° 屏蔽 Shielded

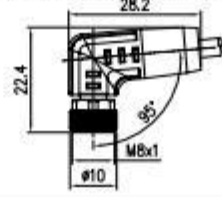

单端预铸线束 With open ended wires

插针 Male 直出 Straight

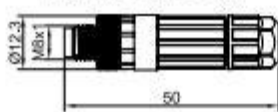

插孔 Female 直出 Straight



插针 Male 90°

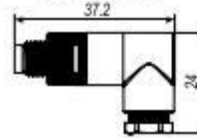

插孔 Female 90°

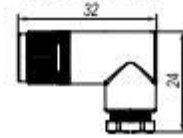

插针 Male 直出 Straight 屏蔽外壳 Shielded

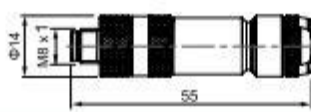

插孔 Female 直出 Straight 屏蔽外壳 Shielded

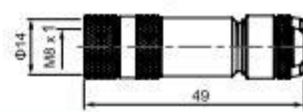

现场接线 / 螺钉压接 Field-wireable / screw terminals

M12 圆形连接器 直出线 Round plug connector straight / 90°

插针 Male 直出 Straight

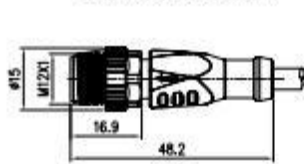

插针 Male 90°

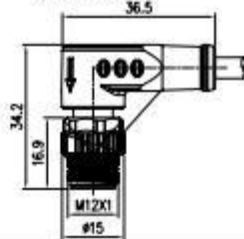

插孔 Female 直出 Straight

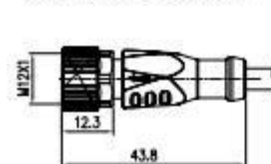

插孔 Female 90°

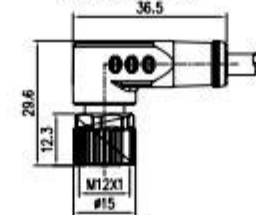

单端预铸线束 With open ended wires

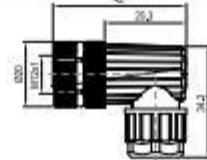
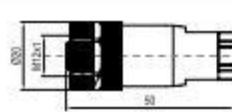
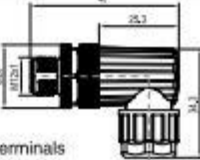
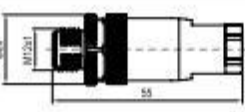

现场接线 / 螺钉压接 Field-wireable / screw terminals

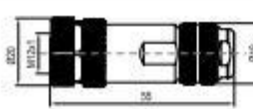
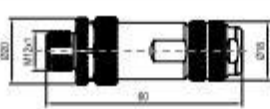

现场接线 / 螺钉压接 / 屏蔽 Field-wireable / screw terminals / shielded

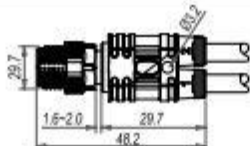

Y型线 Y-distributor

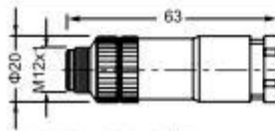

现场接线 / 可接 2 根电缆 Field-wireable / Can receive 2 cables can receive 2 cables

P-02 M8 圆形连接器 ROUND PLUG CONNECTOR

现场接线 Field-wireable



M8 圆形连接器 Round plug connector

插针 Male

- 直出线 / 90°
Straight / 90°

插孔 Female

- 直出线 / 90°
Straight / 90°

页次 page 6.1.1



M8 圆形连接器 Round plug connector

插针 (屏蔽) Male (shielded)

- 直出线 Straight

插孔 (屏蔽) Female (shielded)

- 直出线 Straight

页次 page 6.1.3

单端预铸线束 With open ended wires



M8 圆形连接器 Round plug connector

插针 Male

- 直出线 Straight

插孔 Female

- 90°
- 90° 带 with LED

页次 page 6.1.4



M8 圆形连接器 Round plug connector

插针 Male

- 直出线 Straight

插孔 Female

- 90°

页次 page 6.1.6

双端预铸线束 Connection cable



M8 圆形连接器 Round plug connector

插针 Male

- 直出线 Straight

插孔 Female

- 直出线 Straight

M8 圆形连接器 Round plug connector

插针 Male

- 直出线 Straight

插孔 Female

- 直出线 Straight

- 90°

- 90° 带 with LED

页次 page 6.1.7



M8 圆形连接器 Round plug connector

插针 Male

- 直出线 Straight

- 90°

M12 圆形连接器 Round plug connector

插针 Male

- 直出线 Straight

插孔 Female

- 直出线 Straight

- 90°

- 90° 带 with LED

页次 page 6.1.10

M8 板面安装插座 Panel installed connectors



M8 板面安装插座 Panel installed connectors

插针 Male

- 直出线 Straight

插孔 Female

- 直出线 Straight

法兰安装 Flange installation

P-02 M8 圆形连接器 ROUND PLUG CONNECTOR

现场接线
Field-wireable

免剥线连接 Quick connect

相比螺钉连接节省 60% 时间
Operate time save 60%

插针 Male
直出 Straight

插孔 Female
直出 Straight

对接连接



1 插针型号 Form No.

极数
Suppression

3-pole

3-pole

3-pole

电缆出口直径 Cable outlet diameter

0.14...0.34 mm²

针脚排序
Contact layout

插针 Male



插孔 Female



插孔 Female



插孔 Female

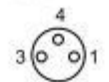

2 技术参数 Technical data

额定电压 Supply voltage

max. 32 V AC/DC

额定电流 Current per contact

max. 4A

连接线径

0.14...0.34 mm² 针 (导线直径 min. 0.1 mm)

端口封盖

螺纹 M8 × 1 mm (推荐扭矩 0.4 Nm) 自锁

压线直径

Φ2.5...5.1 mm (含垫圈)

导线绝缘

PVC, PP, TPE

导线外径

1.0...1.6 mm

防护等级 Protection

IP67- 插孔插针配合拧紧 (EN 60529)

重新连接 (电缆)

10

温度范围 Temperature range

-25...+85°C

尺寸图 Description

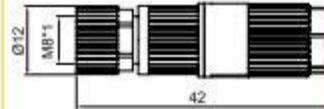
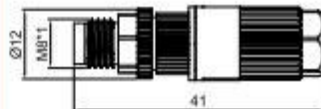

安装说明



1) 去除电缆护套, 长度约为 12-18 毫米



2) 根据线缆大小选择不同款式的垫圈



3) 线缆穿过尾部主体, 垫圈, 剥好的单根线穿过异型胶体



4) 漏出的线缆用剪线钳剪除持平。装好的半成品, 对准前端部件旋转尾端主体使两者结合。

1 型号 Form

P-02 M8 圆形连接器 ROUND PLUG CONNECTOR

现场接线
Field-wireable
螺钉压接
Screw terminals

插针 Male
直出 Straight



插孔 Female
直出 Straight



1 型号 Form No.

极数
Suppression

3-pole

4-pole

3-pole

4-pole

插针 Male
90°



插孔 Female
90°



90° 型号 Form No.

极数
Suppression

3-pole

4-pole

3-pole

4-pole

电路图
Circuit diagram

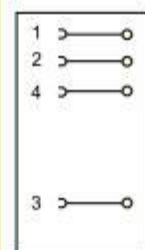
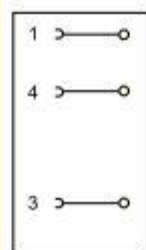
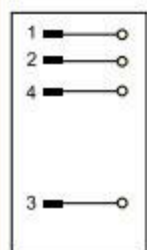
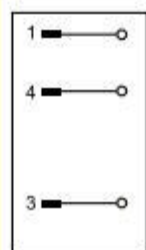

压线范围 Wire diameter

0.14...0.5 mm²0.14...0.5 mm²0.14...0.5 mm²0.14...0.5 mm²

针脚排序
Contact layout

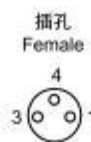
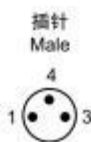

2 技术参数 Technical data

额定电压 Supply voltage

60 V AC/DC

30 V AC/DC

60 V AC/DC

30 V AC/DC

额定电流 Current per contact (40°C)

max. 4 A

压线方式 Wiring method

螺钉压接 Screw terminals

防护等级 Protection

IP67- 插孔插针配合拧紧 (EN 60529) When plugged and screwed down

温度范围 Temperature range

-25...+85°C

电缆出线直径 Clamping range: Cable exit

3.5...5.0 mm

P-02 M8 圆形连接器 ROUND PLUG CONNECTOR

现场接线
Field-wireable
螺钉压接
Screw terminals
屏蔽
Shielded

插针 Male
直出 Straight



插孔 Female
直出 Straight



1 型号 Form No.				
极数 Suppression	3-pole	4-pole	3-pole	4-pole
电路图 Circuit diagram				
压线范围 Wire diameter	0.14...0.5 mm ²	0.14...0.5 mm ²	0.14...0.5 mm ²	0.14...0.5 mm ²
针脚排序 Contact layout				
2 技术参数 Technical data				
额定电压 Supply voltage	60 V AC/DC	30 V AC/DC	60 V AC/DC	30 V AC/DC
额定电流 Current per contact (40°C)	max. 4 A			
压线方式 Wiring method	螺钉压接 Screw terminals			
防护等级 Protection	IP67- 插孔插针配合拧紧 (EN 60529) When plugged and screwed down			
温度范围 Temperature range	-25...+85°C			
电缆出线直径 Clamping range:Cable ext	3.5...5.0 mm			

尺寸图 Description

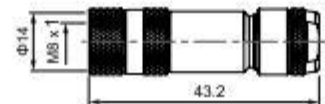
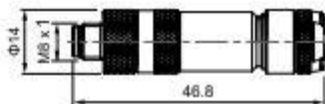

1 型号 Form

P-02 M8 圆形连接器 ROUND PLUG CONNECTOR

单端预铸线束
With open ended wires

插针 Male
直出 Straight



插孔 Female
直出 Straight



1 型号 Form No.				
食品和饮料 FOOD & BEVERAGE	908001F	908011F	908041F	908061F
极数 Suppression	3-pole	4-pole	3-pole	4-pole

插针 Male
90°



插孔 Female
90°



型号 Form No.				
食品和饮料 FOOD & BEVERAGE	908021F	908031F	908081F	908101F
极数 Suppression	3-pole	4-pole	3-pole	4-pole

电路图
Circuit diagram

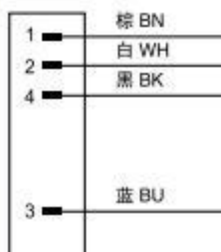

针脚排序
Contact layout



2 电缆类型 Cable type	护套颜色 Jacket color											
导体横截面 0.25mm ²	黄 YE	灰 GY	黑 BK	黄 YE	灰 GY	黑 BK	黄 YE	灰 GY	黑 BK	黄 YE	灰 GY	黑 BK
PVC		210	610		211	611		210	610		211	611
PUR		220	620		221	621		220	620		221	621
PUR 高柔性 Highly flexible			630			631			630			631
抗扭、防飞溅 Torsion, welding spark resistant	150 050			151 051			150 050			151 051		
导体横截面 0.5mm ² 抗扭、防飞溅				174						174		

3 电缆长度 Cable length												
1.5m												
3.0m												
5.0m												
7.5m												
10.0m												

P-02 M8 圆形连接器 ROUND PLUG CONNECTOR

单端预铸线束
With open ended wires

插孔 Female
直出 Straight
带 With LED



插孔 Female
90°
带 With LED



1 型号 Form No.	908261F	908281F	908121F	908283F
食品和饮料 FOOD & BEVERAGE	3-pole 带 2 x LED (PNP)	4-pole 带 3 x LED (PNP)	3-pole 带 2 x LED (PNP)	4-pole 带 3 x LED (PNP)
极数 Suppression	3-polewith 2 x LED (PNP)	4-pole with 3 x LED (PNP)	3-polewith 2 x LED (PNP)	4-pole with 3 x LED (PNP)

电路图
Circuit diagram

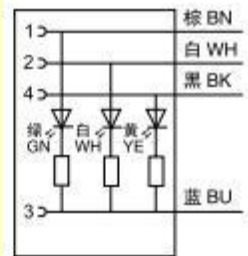
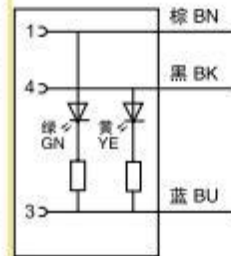
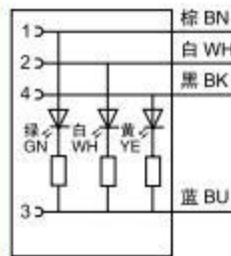
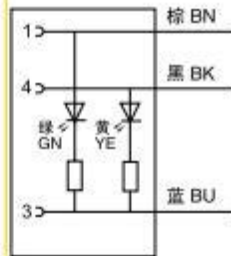

针脚排序
Contact layout

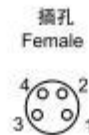
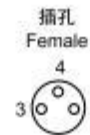
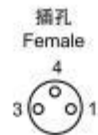

2 电缆类型 Cable type	护套颜色 Jacket color											
导体横截面 0.25mm ²	黄 YE	灰 GY	黑 BK	黄 YE	灰 GY	黑 BK	黄 YE	灰 GY	黑 BK	黄 YE	灰 GY	黑 BK
PVC		210	610		211	611		210	610		211	611
PUR		220	620		221	621		220	620		221	621
PUR 高柔性 Highly flexible			630			631			630			631
抗扭、耐飞弧 Torsion, welding spark resistant	150 050			151 051			150 050			151 051		

3 电缆长度 Cable length
1.5m
3.0m
5.0m
7.5m
10.0m

P-02 M8 圆形连接器 ROUND PLUG CONNECTOR

单端预铸线束
With open ended wires

插针 Male
直出 Straight
屏蔽 Shielded



插孔 Female
直出 Straight
屏蔽 Shielded



P

1 型号 Form No.				
食品和饮料 FOOD & BEVERAGE	908701F	908761F	908045F	908046F
极数 Suppression	3-pole	4-pole	3-pole	4-pole

插针 Male
90°
屏蔽 Shielded



插孔 Female
90°
屏蔽 Shielded



型号 Form No.				
食品和饮料 FOOD & BEVERAGE	908721F	908731F	908085F	908801F
极数 Suppression	3-pole	4-pole	3-pole	4-pole

电路图
Circuit diagram



针脚排序
Contact layout

插针 Male



插针 Male



插孔 Female



插孔 Female



2 电缆类型 Cable type	护套颜色 Jacket color			
导体横截面 0.25mm ²	黑 BK	黑 BK	黑 BK	黑 BK
PUR 高柔性 Highly flexible	707	717	707	717

3 电缆长度 Cable length				
1.5m				
3.0m				
5.0m				
7.5m				
10.0m				

P-02 M8 圆形连接器 ROUND PLUG CONNECTOR

双端预铸线束
Connection cable
-M8-M8

插针 Male
直出 Straight

插孔 Female
直出 Straight

插针 Male
直出 Straight

插孔 Female
90°



1 型号 Form No.	988001F		988011F		988021F		988031F	
食品和饮料 FOOD & BEVERAGE	988001F		988011F		988021F		988031F	
极数 Suppression	3-pole		4-pole		3-pole		4-pole	
电路图 Circuit diagram								
针脚排序 Contact layout								

2 电缆类型 Cable type	护套颜色 Jacket color											
导体横截面 0.25mm ²	黄 YE	灰 GY	黑 BK	黄 YE	灰 GY	黑 BK	黄 YE	灰 GY	黑 BK	黄 YE	灰 GY	黑 BK
PVC		210	610		211	611		210	610		211	611
PUR		220	620		221	621		220	620		221	621
PUR 高柔性 Highly flexible			630			631			630			631
抗扭、防飞溅 Torsion, welding spark resistant	150	050		151	051		150	050		151	051	
导体横截面 0.5mm ² 抗扭、防飞溅				174						174		

3 电缆长度 Cable length
1.5m
3.0m
5.0m
7.5m
10.0m

P-02 M8 圆形连接器 ROUND PLUG CONNECTOR

双端预铸线束
Connection cable

-M8-M8

屏蔽 Shielded

插针 Male
直出 Straight

插孔 Female
直出 Straight

插针 Male
直出 Straight

插孔 Female
90°



1 型号 Form No.

食品和饮料 FOOD & BEVERAGE

极数

Suppression

电路图

Circuit diagram

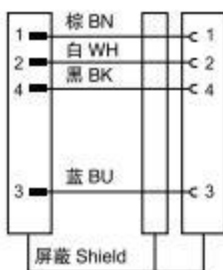

针脚排序

Contact layout

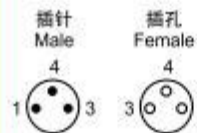
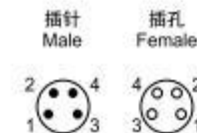
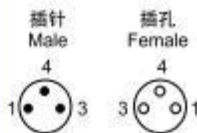

2 电缆类型 Cable type

导体横截面 0.25mm²

PUR 高柔性 Highly flexible

护套颜色 Jacket color

黑 BK

黑 BK

黑 BK

黑 BK

707

717

707

717

3 电缆长度 Cable length

1.5m

3.0m

5.0m

7.5m

10.0m

P-02 M8 圆形连接器 ROUND PLUG CONNECTOR

双端预铸线束
Connection cable
-M8-M8

插针 Male
直出 Straight

插针 Male
直出 Straight

插针 Male
直出 Straight

插孔 Female
90°, 带 with LED



P

1 型号 Form No.

食品和饮料 FOOD & BEVERAGE

988042F (曾用料号 988011T1F)

988041F

极数
Suppression

4-pole

3-pole 带 2 x LED (PNP)

3-pole with 2 x LED (PNP)

电路图
Circuit diagram

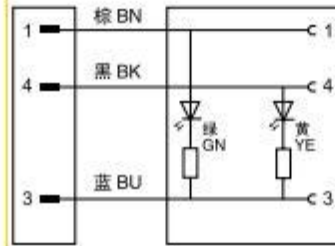
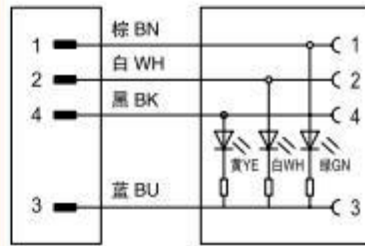

针脚排序
Contact layout

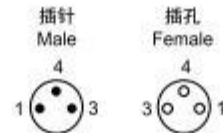
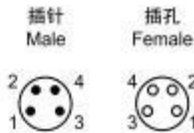

2 电缆类型 Cable type

导体横截面 0.25mm²

护套颜色 Jacket color

	黄 YE	橙 OG	灰 GY	黑 BK	黄 YE	橙 OG	灰 GY	黑 BK
PVC			211	611			210	610
PUR			221	621			220	620
PUR 高柔性 Highly flexible				631				630
抗扭、防飞溅 Torsion, welding spark resistant	151	051			150	050		
导体横截面 0.5mm ² 抗扭、防飞溅	174							

3 电缆长度 Cable length

1.5m

3.0m

5.0m

7.5m

10.0m

P-02 M8 圆形连接器 ROUND PLUG CONNECTOR

双端预铸线束
Connection cable

-M8-M12

插针 Male
直出 Straight

插孔 Female
直出 Straight

插针 Male
直出 Straight

插孔 Female
90°



1 型号 Form No.	988241F			988251F			988261F			988271F		
食品和饮料 FOOD & BEVERAGE	988241F			988251F			988261F			988271F		
极数 Suppression	3-pole			4-pole			3-pole			4-pole		
电路图 Circuit diagram												
针脚排序 Contact layout												
2 电缆类型 Cable type	护套颜色 Jacket color											
导体横截面 0.25mm ²	黄 YE	灰 GY	黑 BK	黄 YE	灰 GY	黑 BK	黄 YE	灰 GY	黑 BK	黄 YE	灰 GY	黑 BK
PVC		210	610		211	611		210	610		211	611
PUR		220	620		221	621		220	620		221	621
PUR 高柔性 Highly flexible			630			631			630			631
抗扭、防飞溅 Torsion, welding spark resistant	150	050		151	051		150	050		151	051	
导体横截面 0.5mm ² 抗扭、防飞溅				174						174		
3 电缆长度 Cable length												
1.5m												
3.0m												
5.0m												
7.5m												
10.0m												

P-02 M8 圆形连接器 ROUND PLUG CONNECTOR

两端预铸线束
Connection cable
-M8-M12

插针 Male
直出 Straight

插孔 Female
90°, 带 with LED



1 型号 Form No.

食品和饮料 FOOD & BEVERAGE

988281F

988291F

极数 3-pole 带 2 x LED (PNP)

4-pole 带 3 x LED (PNP)

Suppression 3-pole with 2 x LED (PNP)

4-pole with 3 x LED (PNP)

电路图

Circuit diagram

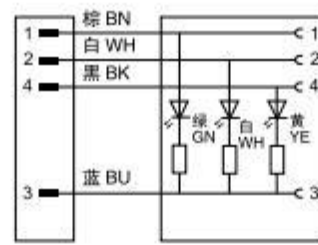
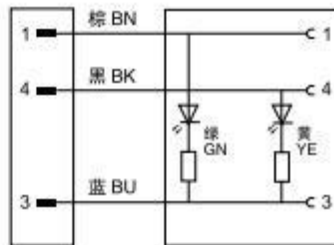

针脚排序

Contact layout

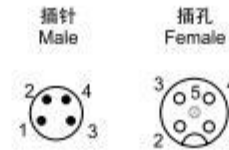
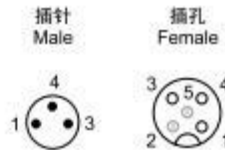

2 电缆类型 Cable type

护套颜色 Jacket color

导体横截面 0.25mm²

黄 YE	橙 OG	灰 GY	黑 BK	黄 YE	橙 OG	灰 GY	黑 BK
------	------	------	------	------	------	------	------

PVC

		210	610			211	611
--	--	-----	-----	--	--	-----	-----

PUR

		220	620			221	621
--	--	-----	-----	--	--	-----	-----

PUR 高柔性 Highly flexible

			630				631
--	--	--	-----	--	--	--	-----

抗扭、防飞溅 Torsion, welding spark resistant

150	050			151	051		
-----	-----	--	--	-----	-----	--	--

导体横截面 0.5mm² 抗扭、防飞溅

				174			
--	--	--	--	-----	--	--	--

3 电缆长度 Cable length

1.5m

3.0m

5.0m

7.5m

10.0m

P-02 M8 圆形连接器 ROUND PLUG CONNECTOR

双端预铸线束
Connection cable

-M8-2M8

插针 Male
Y形直出 Distributor

插孔 Female
直出 Straight



1 型号 Form No.	987011F				987001F				987061F			
食品和饮料 FOOD & BEVERAGE	3 芯				4 / 3 芯				4 芯			
极数 Suppression												
电路图 Circuit diagram												
针脚排序 Contact layout												
2 电缆类型 Cable type	护套颜色 Jacket color											
导体横截面 0.25mm ²	黄 YE	橙 OG	灰 GY	黑 BK	黄 YE	橙 OG	灰 GY	黑 BK	黄 YE	橙 OG	灰 GY	黑 BK
PVC			210	610			210	610			211	611
PUR			220	620			220	620			221	621
PUR 高柔性 Highly flexible				630				630				631
抗扭、防飞弧 Torsion, welding spark resistant	150	050			150	050			151	051		
3 电缆长度 Cable length	1.5m											
	3.0m											
	5.0m											
	7.5m											
	10.0m											
技术参数 Technical data	额定电压 Supply voltage max. 50 V AC/60 V DC											
	防护等级 Protection 插好并拧紧后 IP67 (EN 60529)											
	温度范围 Temperature range -25...+85 °C, 取决于电缆质量											

P-02 板面安装连接器 PANEL INSTALLED CONNECTORS

带线或 PCB 安装
Pre-wired or PCB installation

M8 插针 Male



M8 插孔 Female



1 型号 Form No.

极数 Suppression	3-pole	4-pole	5-pole	3-pole	4-pole	5-pole
电路图 Circuit diagram						
针脚排序 Contact layout						

2 技术参数 Technical data

额定电压 Supply voltage	60 V AC/DC
额定电流 Current per contact (40°C)	4A
防护等级 Protection	IP67-插孔插针配合拧紧(EN 60529) When plugged and screwed down
导体截面积 Connection diameter	0.25 mm ²
温度范围 Temperature range	-25...+85°C

尺寸图 Description

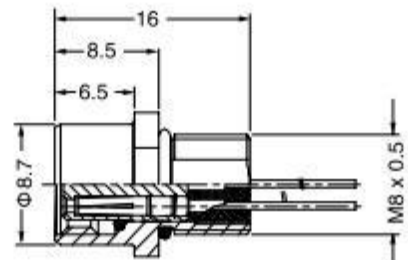
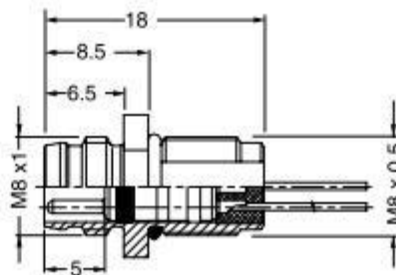

P-02 M8 圆形连接器 ROUND PLUG CONNECTOR

-M8 B-Code

插针 Male
直出 Straight插孔 Female
直出 Straight

1 型号 Form No.

极数 Suppression

5-pole

6-pole

8-pole

5-pole

6-pole

8-pole

插针 Male
90°插孔 Female
90°

型号 Form No.

极数 Suppression

5-pole

6-pole

8-pole

5-pole

6-pole

8-pole

电路图

Circuit diagram



针脚排序

Contact layout

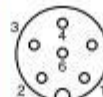
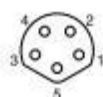
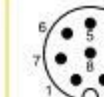
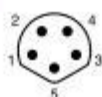

2 电缆类型 Cable type

护套颜色 Jacket color

导体横截面

PVC (3x0.14+2x0.34mm²)PVC (6x0.25mm²)PVC (8x0.25mm²)

黑 BK

黑 BK

黑 BK

黑 BK

黑 BK

黑 BK

612

290

293

612

290

293

3 电缆长度 Cable length

1.5m

3.0m

5.0m

7.5m

10.0m

P-02 M8 圆形连接器 ROUND PLUG CONNECTOR

-M8 B-Code

插针 Male
直出 Straight

底孔 Female
直出 Straight



1 型号 Form No.			
极数 Suppression	5-pole	6-pole	8-pole
电路图 Circuit diagram			
针脚排序 Contact layout			
2 电缆类型 Cable type	护套颜色 Jacket color		
导体横截面	黑 BK (3x0.14+2x0.34mm ²)	黑 BK (6x0.25mm ²)	黑 BK (8x0.25mm ²)
PVC	612	290	293
3 电缆长度 Cable length			
1.5m			
3.0m			
5.0m			
7.5m			
10.0m			

P-02 附件 ACCESSORIES

电缆标识附件 Labeling accessories		适用范围 Suitable for
	滑动电缆套管 Slip-on cable sleeves 4x18 mm	电缆直径 4.0...6.5 mm Cable diameter 4.0...6.5 mm
	可拆卸电缆套管 Snap-on cable sleeves 4x18 mm	电缆直径 4.2...7.0 mm Cable diameter 4.2...7.0 mm
	标识板 Label plates 4x18 mm	
	M8 连接器安装扳手	
	M8 母头塑料保护盖 Plastic screw plug M8	
	M12 公头塑料保护盖 Male blind plug (Plastic) M12 母头塑料保护盖 Female blind plug (Plastic)	

连接器固定器

名称 Identification	型号 Type	应用图
SHD 连接器固定器 适用于 M8 预铸线 M4 螺丝	SHD 8 4	 M8 预铸线
SHD 连接器固定器 适用于 M8 现场接线与 M12 预铸线 M4 螺丝	SHD 12 4	 M8 现场接线  M12 预铸线



P-03 M12 圆形连接器 ROUND PLUG CONNECTOR

现场接线 Field-wireable



M12 圆形连接器 Round plug connector

插针 Male

- 直出线 / 90°
Straight / 90°

插孔 Female

- 直出线 / 90°
Straight / 90°

页次 page 6.2.1



M12 圆形连接器 Round plug connector

屏蔽 Shielded

插针 Male

- 直出线 / 90°
Straight / 90°

插孔 Female

- 直出线 / 90°
Straight / 90°

页次 page 6.2.6

单端预铸线束 With open ended wires



M12 圆形连接器 Round plug connector

插针 Male

- 直出线 Straight

插孔 Female

- 90°

插孔 Female 带 With LED

页次 page 6.2.10



M12 圆形连接器 Round plug connector

插针 Male

- 直出线 Straight

屏蔽 Shielded

- 90°

页次 page 6.2.14

双端预铸线束 Connection cable



M12 圆形连接器 Round plug connector

插针 Male

- 直出线 Straight
- 90°

M12 圆形连接器 Round plug connector

插孔 Female

- 直出线 Straight
- 90°

页次 page 6.2.16



M12 圆形连接器 Round plug connector

插针 Male

- 直出线 Straight

M8 圆形连接器 Round plug connector

插孔 Female

- 直出线 Straight
- 90°
- 90° 带 With LED

页次 page 6.2.18



M12 圆形连接器 Round plug connector

插针 Male

- 直出线 Straight

M12 圆形连接器 Round plug connector

插孔 Female

- 90°
- 90° 带 With LED

P-03 M12 圆形连接器 ROUND PLUG CONNECTOR

双端预铸线束 Connection cable



M12 圆形连接器 Round plug connector
插针 Male • 直出线 Straight
屏蔽 Shielded

M12 圆形连接器 Round plug connector
插孔 Female • 直出线 Straight
屏蔽 Shielded • 90°

页次 page 6.2.21



M12 圆形连接器 Round plug connector-Y 型线
插针 Male • 直出线 Straight

M12 圆形连接器 Round plug connector
插孔 Female • 直出线 Straight
• 90°
• 90° 带 With LED

页次 page 6.2.22



M12 圆形连接器 Round plug connector-Y 型线
插针 Male • 直出线 Straight

M8 圆形连接器 Round plug connector
插孔 Female • 直出线 Straight
• 90°
• 90° 带 With LED

页次 page 6.2.25

M12 板面安装插座 Panel installed connectors



板后安装连接器 Panel installed connectors

插针、插孔 4-pole A-code、B-code、D-code
Male / Female 5-pole A-code、B-code
8-pole B-code

页次 page 6.2.27



板前安装连接器 Panel installed connectors

插针、插孔 4-pole A-code、B-code、D-code
Male/Female 5-pole A-code、B-code
8-pole B-code

页次 page 6.2.28



印制电路板安装连接器 PCB connectors

插针、插孔 4-pole A-code、B-code、D-code
Male/Female 5-pole A-code、B-code
8-pole B-code

页次 page 6.2.29



PCB 安装连接器 Install the connector for

插针、插孔 90° 4-pole
Male / Female 90° 5-pole

页次 page 6.2.31



控制柜引入系统 Control cabinet entry system

插针、插孔 4-pole D-code
Male/Female 5-pole
5-pole B-code

• 对应 Profibus-DP and Interbus

P-03 M12 圆形连接器 ROUND PLUG CONNECTOR

现场接线
Field-wireable

免剥线连接 Quick connect

相比螺钉连接节省 60% 时间
Operate time save 60%

插针 Male
直出 Straight



插孔 Female
直出 Straight



对接连接



1 插针型号 Form No.

极数
Suppression

4-pole

4-pole

4-pole

电缆出口直径 Cable outlet diameter

0.14...0.34 mm²

针脚排序
Contact layout

插针 Male



插孔 Female



插孔 Female



插孔 Female



2 技术参数 Technical data

额定电压 Supply voltage

max. 125 V AC/DC

额定电流 Current per contact

max. 4A

连接线径

0.14...0.34 mm² (导线直径 min. 0.1 mm)

端口封盖

螺纹 M12 × 1 mm (推荐扭距 0.6 Nm) 自锁

线缆直径

Φ2.9...5.8 mm

绝缘电阻

≥ 100 mΩ

导线外径

1.0...1.6 mm

防护等级 Protection

IP67- 插孔插针配合拧紧 (EN 60529)

温度范围 Temperature range

-25...+85°C

尺寸图 Description

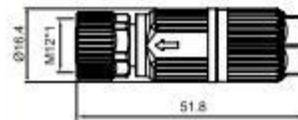
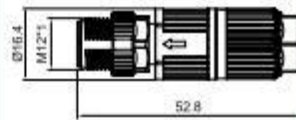

安装说明

度约为



度约为 12-18 毫米
度约为 7-8 毫米



不同款式的垫圈
根据线缆大小选择



三) 线缆穿过尾端主体
垫圈, 异型锁紧芯



四) 单根线按入标记电
线导向器中, 直至它们
卡入



五) 漏出的线缆用剪线
钳剪除持平



六) 对准前芯端型锁紧
体入锁紧芯, 旋紧旋紧
使两者结合, 尾部标
识上端后主标识

1 型号 Form

P-03 M12 圆形连接器 ROUND PLUG CONNECTOR

现场接线
Field-wireable插针 Male
直出 Straight插孔 Female
直出 Straight

金属螺母



1	极数 Suppression	4-pole	5-pole	4-pole	5-pole
	螺钉压接 With screw terminals				
	弹片压接 Cage-clamp terminals				
	电缆出口直径 Cable outlet diameter	4...6 mm 6...8 mm	4...6 mm 6...8 mm	4...6 mm 6...8 mm	4...6 mm 6...8 mm
	针脚排序 Contact layout				
	螺钉压接 With screw terminals				
	弹片压接 Cage-clamp terminals				
	电缆出口直径 Cable outlet diameter	6...8 mm	6...8 mm	6...8 mm	6...8 mm
	针脚排序 Contact layout				
	螺钉压接 With screw terminals				
	弹片压接 Cage-clamp terminals				
	电缆出口直径 Cable outlet diameter	6...8 mm		6...8 mm	
	针脚排序 Contact layout				
	电路图 Circuit diagram				
2	技术参数 Technical data				
	额定电压 Supply voltage	250 V AC/DC	125 V AC/DC	250 V AC/DC	125 V AC/DC
	额定电流 Current per contact (40°C)	max. 4 A			
	压线范围 Connection diameter	最大 max. 0.75 mm ²			
	外壳材料 Housing material	阻燃塑料 Flame retardant plastic			
	防护等级 Protection	IP67- 插孔插针配合拧紧 (EN 60529) When plugged and screwed down			
	温度范围 Temperature range	-25...+85°C			
	尺寸图 Description				

P-03 M12 圆形连接器 ROUND PLUG CONNECTOR

现场接线
Field-wireable

螺钉压接
With screw terminals

插针 Male
直出 Straight



插孔 Female
直出 Straight



1 型号 Form No.				
极数 Suppression	4-pole	5-pole	4-pole	5-pole
电缆出口直径 Cable outlet diameter	8...10 mm	8...10 mm	8...10 mm	8...10 mm

双孔

插针 Male
直出 Straight



插孔 Female
直出 Straight



1 型号 Form No.				
极数 Suppression	4-pole	5-pole	4-pole	5-pole
电缆出口直径 Cable outlet diameter	2x(3...5.2) mm	2x(3...5.2) mm	2x(3...5.2) mm	2x(3...5.2) mm

针脚排序 Contact layout



电路图 Circuit diagram

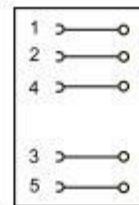
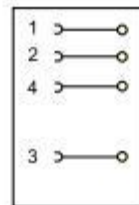
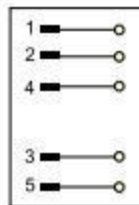
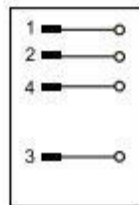

2 技术参数 Technical data				
额定电压 Supply voltage	250 V AC/DC	60 V AC/DC	250 V AC/DC	60 V AC/DC
额定电流 Current per contact (40°C)	max. 4 A			
压线范围 Connection diameter	最大 max. 0.75 mm ²			
外壳材料 Housing material	阻燃塑料 Flame retardant plastic			
防护等级 Protection	IP67- 插孔插针配合拧紧 (EN 60529) When plugged and screwed down			
温度范围 Temperature range	-25...+85°C			

P-03 M12 圆形连接器 ROUND PLUG CONNECTOR

现场接线
Field-wireable

金属螺母

插针 Male
90°插孔 Female
90°

1	极数 Suppression	4-pole	5-pole	4-pole	5-pole
螺钉压接 With screw terminals					
弹片压接 Cage-clamp terminals					
电缆出口直径 Cable outlet diameter		4...6 mm 6...8 mm	4...6 mm 6...8 mm	4...6 mm 6...8 mm	4...6 mm 6...8 mm
针脚排序 Contact layout					
螺钉压接 With screw terminals					
弹片压接 Cage-clamp terminals					
电缆出口直径 Cable outlet diameter		6...8 mm	6...8 mm	6...8 mm	6...8 mm
针脚排序 Contact layout					
D-Code 订货号 Part No.					
螺钉压接 With screw terminals					
弹片压接 Cage-clamp terminals					
电缆出口直径 Cable outlet diameter		6...8 mm		6...8 mm	
针脚排序 Contact layout					
电路图 Circuit diagram					
2	技术参数 Technical data				
额定电压 Supply voltage		250 V AC/DC	125 V AC/DC	250 V AC/DC	125 V AC/DC
额定电流 Current per contact (40°C)		max. 4 A			
压线范围 Connection diameter		最大 max. 0.75 mm ²			
外壳材料 Housing material		阻燃塑料 Flame retardant plastic			
防护等级 Protection		IP67- 插孔插针配合拧紧 (EN 60529) When plugged and screwed down			
温度范围 Temperature range		-25...+85°C			
尺寸图 Description					

P-03 M12 圆形连接器 ROUND PLUG CONNECTOR

现场接线
Field-wireable

全塑料外壳

耐腐蚀

插针 Male
直出 Straight



插孔 Female
直出 Straight



1	极数 Suppression	4-pole	5-pole	4-pole	5-pole
	螺钉压接 With screw terminals				
	弹片压接 Cage-clamp terminals				

插针 Male
90°



插孔 Female
90°



1	极数 Suppression	4-pole	5-pole	4-pole	5-pole
	螺钉压接 With screw terminals				
	弹片压接 Cage-clamp terminals				
	电缆出口直径 Cable outlet diameter	4...6 mm	6...8 mm	4...6 mm	6...8 mm

针脚排序 Contact layout



电路图 Circuit diagram

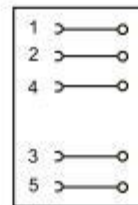
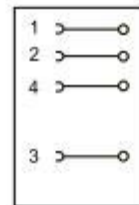
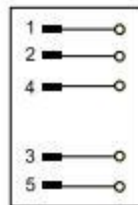
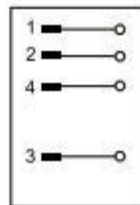

2	技术参数 Technical data				
	额定电压 Supply voltage	250 V AC/DC	125 V AC/DC	250 V AC/DC	125 V AC/DC
	额定电流 Current per contact (40°C)	max. 4 A			
	压线范围 Connection diameter	最大 max. 0.75 mm ²			
	外壳材料 Housing material	阻燃塑料 Flame retardant plastic			
	防护等级 Protection	IP67- 插孔插针配合拧紧 (EN 60529) When plugged and screwed down			
	温度范围 Temperature range	-25...+85°C			

尺寸图 Description

P-03 M12 圆形连接器 ROUND PLUG CONNECTOR

现场接线
Field-wireable

螺钉压接
With screw terminals

插针 Male
直出 Straight



插孔 Female
直出 Straight



1 型号 Form No.

极数
Suppression

8-pole

8-pole

插针 Male
90°



插孔 Female
90°



90° 型号 Form No.

极数
Suppression

8-pole

8-pole

电路图
Circuit diagram

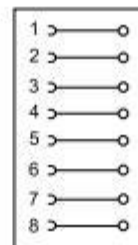
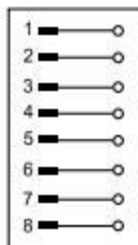

电缆出口直径 Cable outlet diameter

6...8 mm

6...8 mm

针脚排序
Contact layout

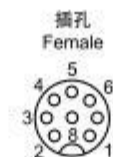
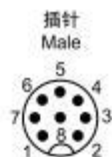

2 技术参数 Technical data

额定电压 Supply voltage 60 V AC/DC

额定电流 Current per contact (40°C) max. 2 A

压线范围 Connection diameter 最大 max. 0.5 mm²

外壳材料 Housing material 阻燃塑料 Flame retardant plastic

压线方式 Wiring method 螺钉压接 Screw terminals

防护等级 Protection IP67- 插孔插针配合拧紧 (EN 60529) When plugged and screwed down

温度范围 Temperature range -25...+85°C

1 型号 Form

P-03 M12 圆形连接器 ROUND PLUG CONNECTOR

现场接线
Field-wireable
金属外壳
Metal housing
屏蔽
Shielded

插针 Male
直出 Straight



插孔 Female
直出 Straight



1 极数 Suppression	4-pole	5-pole	4-pole	5-pole
螺钉压接 With screw terminals				
弹片压接 Cage-clamp terminals				
针脚排序 Contact layout				
螺钉压接 With screw terminals				
弹片压接 Cage-clamp terminals				
针脚排序 Contact layout				
螺钉压接 With screw terminals				
弹片压接 Cage-clamp terminals				
针脚排序 Contact layout				
电缆出口直径 Cable outlet diameter	4...6 mm	6...8 mm	4...6 mm	6...8 mm
电路图 Circuit diagram				

2 技术参数 Technical data

额定电压 Supply voltage	125 V AC/DC
额定电流 Current per contact (40°C)	max. 4 A
压线范围 Connection diameter	最大 max. 0.75 mm ²
外壳材料 Housing material	铜锌合金, 表面镀镍 CuZn, nickel plated
压线方式 Wiring method	螺钉压接 Screw terminals
防护等级 Protection	IP67- 插孔插针配合拧紧 (EN 60529) When plugged and screwed down
温度范围 Temperature range	-25...+85°C

尺寸图 Description

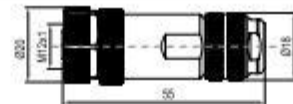
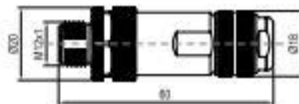

P-03 M12 圆形连接器 ROUND PLUG CONNECTOR

现场接线
Field-wireable
金属外壳
屏蔽
Shielded

插针 Male
90°



插孔 Female
90°



1 极数 Suppression	4-pole	5-pole	4-pole	5-pole
针脚排序 Contact layout				
针脚排序 Contact layout				
针脚排序 Contact layout				
电缆出口直径 Cable outlet diameter	4...6 mm	6...8 mm	4...6 mm	6...8 mm
电路图 Circuit diagram				
2 技术参数 Technical data				
额定电压 Supply voltage	125 V AC/DC			
额定电流 Current per contact (40°C)	max. 4 A			
压线范围 Connection diameter	最大 max. 0.75 mm ²			
外壳材料 Housing material	铜锌合金, 表面镀镍 CuZn, nickel plated			
压线方式 Wiring method	螺钉压接 Screw terminals			
防护等级 Protection	IP67- 插孔插针配合拧紧 (EN 60529) When plugged and screwed down			
温度范围 Temperature range	-25...+85°C			

尺寸图 Description

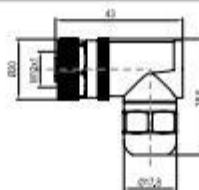
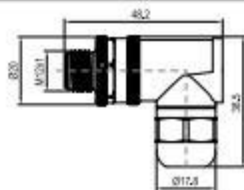

P-03 M12 圆形连接器 ROUND PLUG CONNECTOR

现场接线
Field-wireable
螺钉压接
With screw terminals
屏蔽
Shielded

插针 Male
直出 Straight



插孔 Female
直出 Straight



1 型号 Form No.

极数
Suppression

8-pole

8-pole

插针 Male
90°



插孔 Female
90°



90° 型号 Form No.

极数
Suppression

8-pole

8-pole

电路图
Circuit diagram

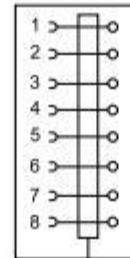
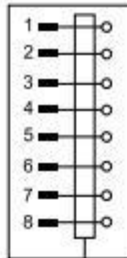

压线范围 Wire diameter

6...8mm

针脚排序
Contact layout

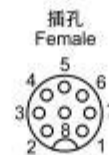
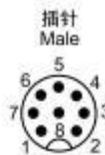

2 技术参数 Technical data

额定电压 Supply voltage	60 V AC/DC
额定电流 Current per contact (40°C)	2A
压线范围 Connection diameter	最大 max. 0.5 mm ²
外壳材料 Housing material	铜锌合金, 表面镀镍 CuZn, nickel plated
压线方式 Wiring method	螺钉压接 Screw terminals
防护等级 Protection	IP67- 插孔插针配合拧紧 (EN 60529) When plugged and screwed down
温度范围 Temperature range	-25...+85°C

P-03 M12 组装式推拉自锁连接器 PUSH/PULL

无需工具
即可轻松插入实现自锁

屏蔽
Shielded

插针 Male A-Code
直出 Straight



插针 Male D-Code
直出 Straight



插针 Male X-Code
直出 Straight



1 型号 Form No.

极数
Suppression

4-pole

5-pole

4-pole

8-pole

针脚排序
Contact layout



插孔 Female A-Code
直出 Straight



插孔 Female D-Code
直出 Straight



插孔 Female X-Code
直出 Straight



底座型号 Form No.

极数
Suppression

4-pole

5-pole

4-pole

8-pole

针脚排序
Contact layout

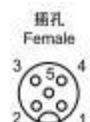

2 技术参数 Technical data

额定电压 Supply voltage	50 V AC/DC
额定电流 Current per contact (40°C)	4A
压线范围 Wire diameter	5.7 ... 8.8 mm
防护等级 Protection	IP67- 插孔插针配合拧紧 (EN 60529) When plugged and screwed down
温度范围 Temperature range	-25...+85°C

P-03 M12 圆形连接器 ROUND PLUG CONNECTOR

单端预铸线束
With open ended wires

插针 Male
直出 Straight



插孔 Female
直出 Straight



1 型号 Form No.

食品和饮料 FOOD & BEVERAGE	912001F	912021F	912041F	912181F	912221F	912241F
极数 Suppression	3-pole	4-pole	5-pole	3-pole	4-pole	5-pole

插针 Male
90°



插孔 Female
90°



型号 Form No.

食品和饮料 FOOD & BEVERAGE	912081F	912101F	912121F	912321F	912341F	912361F
极数 Suppression	3-pole	4-pole	5-pole	3-pole	4-pole	5-pole

电路图

Circuit diagram



针脚排序

Contact layout



2 电缆类型 Cable type

导体横截面 0.34mm²

导体横截面 0.34mm ²	护套颜色 Jacket color		护套颜色 Jacket color		护套颜色 Jacket color		护套颜色 Jacket color		护套颜色 Jacket color		护套颜色 Jacket color	
	灰 GY	黑 BK	灰 GY	黑 BK	灰 GY	黑 BK	灰 GY	黑 BK	灰 GY	黑 BK	灰 GY	黑 BK
PVC	213	613	214	614	215	615	213	613	214	614	215	615
PUR	223	623	224	624	225	625	223	623	224	624	225	625
PUR 高柔性 Highly flexible		633		634		635		633		634		635
抗扭、防飞溅 Torsion, welding spark resistant			154	054					154	054		
导体横截面 0.5mm ² (抗扭、防飞溅)			174						174			

3 电缆长度 Cable length

1.5m	
3.0m	
5.0m	
7.5m	
10.0m	

P-03 M12 圆形连接器 ROUND PLUG CONNECTOR

单端预铸线束
With open ended wires

插针 Male
直出 Straight

插孔 Female
直出 Straight



1 型号 Form No.						
食品和饮料 FOOD & BEVERAGE	917001F	919001F	927001F	917041F	919041F	927041F
极数 Suppression	8-pole	12-pole	17-pole	8-pole	12-pole	17-pole

插针 Male
90°



插孔 Female
90°



型号 Form No.						
食品和饮料 FOOD & BEVERAGE	917021F	919021F	927021F	917061F	919061F	927061F
极数 Suppression	8-pole	12-pole	17-pole	8-pole	12-pole	17-pole

电路图
Circuit diagram



针脚排序
Contact layout

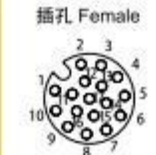
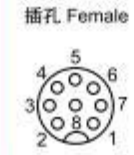
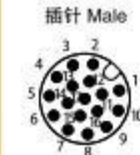
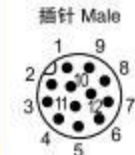
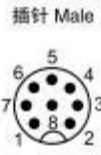

2 电缆类型 Cable type	护套颜色 Jacket color					
导体横截面 0.25mm ²	灰 GY	灰 GY		灰 GY	灰 GY	
PVC	292	301		292	301	
PUR 高柔性 Highly flexible	295			295		
导体横截面 0.14mm ²		黑 BK	黑 BK		黑 BK	黑 BK
PVC		702	742		702	742
PUR 高柔性 Highly flexible		705	745		705	745

3 电缆长度 Cable length	
1.5m	
3.0m	
5.0m	
7.5m	
10.0m	

技术参数 Technical data

工作电压 Supply voltage	max. 30 V AC/DC
防护等级 Protection	IP67- 插孔插针配合拧紧 (EN 60529) When plugged and screwed down
温度范围 Temperature range	-25...+85°C

P-03 M12 圆形连接器 ROUND PLUG CONNECTOR

单端预铸线束
With open ended wires
带 LED
With LED

插孔 Female
直出 Straight



插孔 Female
90°



1 型号 Form No.	912261F	912281F	912381F	912401F
食品和饮料 FOOD & BEVERAGE	3-pole带2xLED(PNP)	4-pole带2xLED(PNP)	3-pole带2xLED(PNP)	4-pole带2xLED(PNP)
极数 Suppression	3-pole with 2 x LED (PNP)	4-pole with 2 x LED (PNP)	3-pole with 2 x LED (PNP)	4-pole with 2 x LED (PNP)

电路图
Circuit diagram

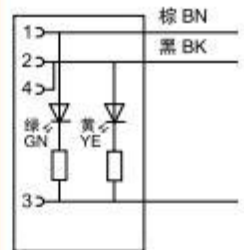
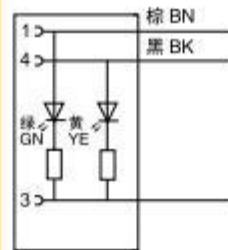
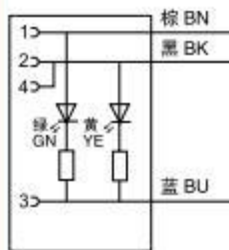
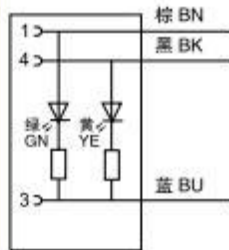

针脚排序
Contact layout

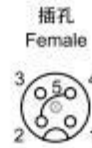
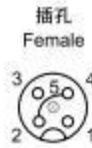
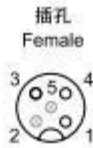

2 电缆类型 Cable type	护套颜色 Jacket color							
导体横截面 0.34mm ²	灰 GY	黑 BK	灰 GY	黑 BK	灰 GY	黑 BK	灰 GY	黑 BK
PVC	213	613	213	613	213	613	213	613
PUR	223	623	223	623	223	623	223	623
PUR 高柔性 Highly flexible		633		633		633		633

3 电缆长度 Cable length
1.5m
3.0m
5.0m
7.5m
10.0m

P-03 M12 圆形连接器 ROUND PLUG CONNECTOR

单端预铸线束
With open ended wires

带 LED
With LED

插孔 Female
90°



1 型号 Form No.	912421F		912441F			
食品和饮料 FOOD & BEVERAGE	912421F		912441F			
极数 Suppression	4-pole带3xLED(PNP) 4-pole with 3 x LED (PNP)		5-pole带3xLED(PNP) 5-pole with 3 x LED (PNP)			
电路图 Circuit diagram						
针脚排序 Contact layout						
2 电缆类型 Cable type	护套颜色 Jacket color					
导体横截面 0.34mm ²	黄 YE	橙 OG	灰 GY	黑 BK	灰 GY	黑 BK
PVC			214	614	215	615
PUR			224	624	225	625
PUR 高柔性 Highly flexible				634		635
抗扭、防飞溅 Torsion, welding spark resistant	154	054				

3 电缆长度 Cable length
1.5m
3.0m
5.0m
7.5m
10.0m

P-03 M12 圆形连接器 ROUND PLUG CONNECTOR

单端预铸线束
With open ended wires

屏蔽
Shielded

插针 Male
直出 Straight



1 型号 Form No.

食品和饮料 FOOD & BEVERAGE	913061F	913081F	913101F	917081F	919301F
极数 Suppression	3-pole	4-pole	5-pole	8-pole	12-pole

插针 Male
90°



型号 Form No.

食品和饮料 FOOD & BEVERAGE	913121F	913141F	913161F	917101F	919321F
极数 Suppression	3-pole	4-pole	5-pole	8-pole	12-pole

电路图
Circuit diagram

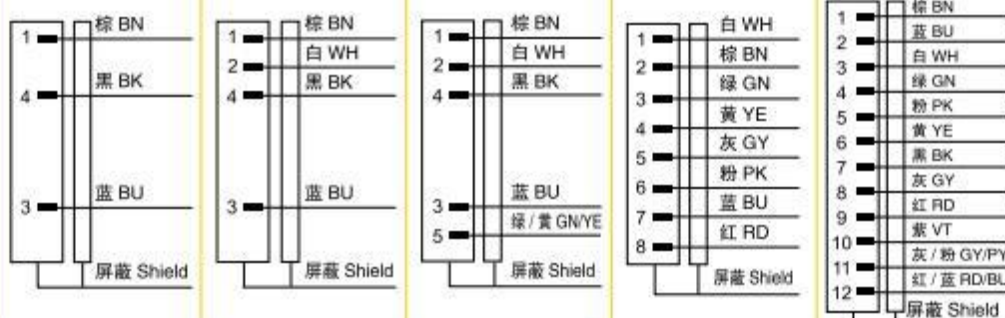

针脚排序
Contact layout



2 电缆类型 Cable type

护套颜色 Jacket color

导体横截面 0.34mm ²	灰 GY	灰 GY	灰 GY		
PVC	317	330	348		
PUR	318	331	349		
导体横截面 0.25mm ²				黑 BK 灰 GY	
PVC				294	
PUR				297	
导体横截面 2					黑 BK
PVC					703
PUR 高柔性 Highly flexible					706

3 电缆长度 Cable length

1.5m					
3.0m					
5.0m					
10.0m					

技术参数 Technical data

工作电压 Supply voltage	125 V AC/DC	60 V AC/DC	30 V AC/DC
额定电流 Current per contact(40°C)	max. 4A	max. 2 A	
防护等级 Protection	IP67- 插孔插针配合拧紧 (EN 60529) When plugged and screwed down		
温度范围 Temperature range	-25...+85°C		

电缆参数 Cable parameter: 8.3.1 尺寸参数 Size parameter: 6.0.4 配件页面 Accessories on page: 6.2.33

P-03 M12 圆形连接器 ROUND PLUG CONNECTOR

单端预铸线束
With open ended wires

屏蔽
Shielded

插孔 Female
直出 Straight



1 型号 Form No.

食品和饮料 FOOD & BEVERAGE

极数 Suppression

913181F

913201F

913221F

917121F

919341F

插孔 Female
90°



型号 Form No.

食品和饮料 FOOD & BEVERAGE

极数 Suppression

913241F

913261F

913281F

917141F

919361F

电路图

Circuit diagram



针脚排序

Contact layout

插孔 Female



插孔 Female



插孔 Female



插孔 Female



插孔 Female



2 电缆类型 Cable type

护套颜色 Jacket color

导体横截面 0.34mm²

灰 GY

灰 GY

灰 GY

PVC

317

330

348

PUR

318

331

349

导体横截面 0.25mm²

PVC

黑 BK 灰 GY

PUR

294

297

导体横截面 0.14mm²

PVC

黑 BK

PUR 高柔性 Highly flexible

703

706

3 电缆长度 Cable length

1.5m

3.0m

5.0m

10.0m

技术参数 Technical data

工作电压 Supply voltage

125 V AC/DC

60 V AC/DC

30 V AC/DC

额定电流 Current per contact(40°C)

max. 4A

max. 2 A

防护等级 Protection

IP67- 插孔插针配合拧紧 (EN 60529) When plugged and screwed down

温度范围 Temperature range

-25...+85°C

P-03 M12 圆形连接器 ROUND PLUG CONNECTOR

双端预铸线束
Connection cable
-M12-M12

插针 Male
直出 Straight

插孔 Female
直出 Straight



1 型号 Form No.

食品和饮料 FOOD & BEVERAGE	940001F	940021F	940041F	948001F
极数 Suppression	3-pole	4-pole	5-pole	8-pole

插针 Male
90°

插孔 Female
90°



型号 Form No.

食品和饮料 FOOD & BEVERAGE	940172F	940202F	940222F	948004F
极数 Suppression	3-pole	4-pole	5-pole	8-pole

电路图
Circuit diagram



针脚排序
Contact layout



2 电缆类型 Cable type

导体横截面 0.34mm²

PVC	灰 GY	黑 BK	黄 YE	灰 GY	黑 BK	灰 GY	黑 BK
	213	613		214	614	215	615
PUR							
	223	623		224	624	225	625
PUR 高柔性 Highly flexible		633		634			635

抗扭、防飞溅 Torsion, welding spark resistant

导体横截面 0.5mm² (抗扭、防飞溅)

导体横截面 0.25mm²

PVC						灰 GY
						292
PUR						295

3 电缆长度 Cable length

1.5m
3.0m
5.0m
7.5m
10.0m

P-03 M12 圆形连接器 ROUND PLUG CONNECTOR

双端预铸线束
Connection cable
-M12-M12

插针 Male
直出 Straight



插孔 Female
90°

1 型号 Form No.				
食品和饮料 FOOD & BEVERAGE	940101F	940121F	940141F	948002F
极数 Suppression	3-pole	4-pole	5-pole	8-pole

插针 Male
90°

插孔 Female
直出 Straight



型号 Form No.				
食品和饮料 FOOD & BEVERAGE	940171F	940201F	940221F	948003F
极数 Suppression	3-pole	4-pole	5-pole	8-pole

电路图
Circuit diagram

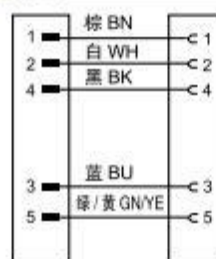
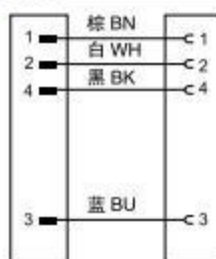
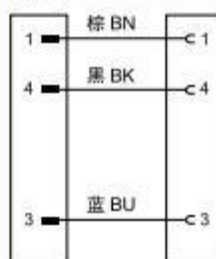

针脚排序
Contact layout

插针 Male

插孔 Female

插针 Male

插孔 Female

插针 Male

插孔 Female

插针 Male

插孔 Female



2 电缆类型 Cable type 护套颜色 Jacket color

导体横截面 0.34mm ²	灰 GY	黑 BK	黄 YE	灰 GY	黑 BK	灰 GY	黑 BK
PVC	213	613		214	614	215	615
PUR	223	623		224	624	225	625
PUR 高柔性 Highly flexible		633			634		635
抗扭、防飞溅 Torsion, welding spark resistant			154	054			
导体横截面 0.5mm ² (抗扭、防飞溅)			174				
导体横截面 0.25mm ²						灰 GY	
PVC						292	
PUR						295	

3 电缆长度 Cable length

0.3m
0.6m
1.0m
1.5m
2.0m

P-03 M12 圆形连接器 ROUND PLUG CONNECTOR

双端预铸线束
Connection cable

M12
插针 Male
直出 Straight

M8
插孔 Female
直出 Straight

M12
插针 Male
直出 Straight

M8
插孔 Female
90°



1	型号 Form No.	940561F			940581F			940601F			940621F		
食品和饮料 FOOD & BEVERAGE	极数 Suppression	3-pole			4-pole			3-pole			4-pole		
电路图 Circuit diagram													
针脚排序 Contact layout													
2	电缆类型 Cable type	护套颜色 Jacket color											
	导体横截面 0.25mm ²	黄 YE	灰 GY	黑 BK	黄 YE	灰 GY	黑 BK	黄 YE	灰 GY	黑 BK	黄 YE	灰 GY	黑 BK
	PVC		210	610		211	611		210	610		211	611
	PUR		220	620		221	621		220	620		221	621
	PUR 高柔性 Highly flexible			630			631			630			631
	抗扭、耐飞溅 Torsion, welding spark resistant	150	050	650	151	051		150	050	650	151	051	
3	电缆长度 Cable length												
	0.3m												
	0.6m												
	1.0m												
	1.5m												
	2.0m												

电缆参数 Cable parameter: 8.3.1 尺寸参数 Size parameter: 6.0.4 配件页面 Accessories on page: 6.2.33

P-03 M12 圆形连接器 ROUND PLUG CONNECTOR

双端预铸线束
Connection cable
-M12-M8/M12

M12
插针 Male
直出 Straight

M8
插孔 Female
90° with 带 LED
M8

M12
插针 Male
直出 Straight

M12
插孔 Female
90° with 带 LED
M12



1 型号 Form No.

食品和饮料 FOOD & BEVERAGE

极数

Suppression

电路图

Circuit diagram

引脚排序

Contact layout

940641F

3-pole带2xLED(PNP)

3-pole with 2 x LED (PNP)

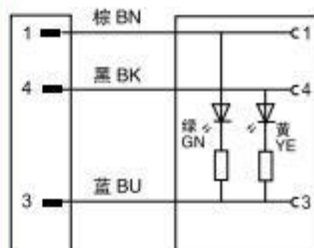

940381F

3-pole 带2xLED (PNP)

3-pole with 2 x LED (PNP)

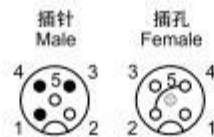
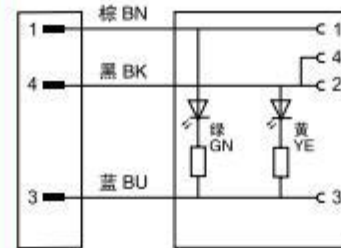

2 电缆类型 Cable type

导体横截面

PVC

PUR

PUR 高柔性 Highly flexible

抗扭、防飞溅 Torsion, welding spark resistant

护套颜色 Jacket color

黄 YE

橙 OG

灰 GY

黑 BK

芯线直径 Wire 0.25mm²

210

220

150

050

610

620

630

650

芯线直径 Wire 0.34mm²

灰 GY

黑 BK

213

223

633

613

623

633

3 电缆长度 Cable length

0.3m

0.6m

1.0m

1.5m

2.0m

P-03 M12 圆形连接器 ROUND PLUG CONNECTOR

双端预铸线束
Connection cable
-M12-M12

插针 Male
直出 Straight

插孔 Female
90° with 带 LED



1 型号 Form No.	940321F		940341F		940361F	
食品和饮料 FOOD & BEVERAGE	940321F		940341F		940361F	
极数 Suppression	3-pole 带2xLED (PNP) 3-pole with 2 x LED (PNP)		4-pole 带3xLED (PNP) 4-pole with 3 x LED (PNP)		5-pole 带3xLED (PNP) 5-pole with 3 x LED (PNP)	
电路图 Circuit diagram						
针脚排序 Contact layout						
2 电缆类型 Cable type	护套颜色 Jacket color					
导体横截面 0.34mm ²	灰 GY	黑 BK	黄 YE	灰 GY	黑 BK	灰 GY 黑 BK
PVC	213	613		214	614	215 615
PUR	223	623		224	624	225 625
PUR 高柔性 Highly flexible		633			634	
抗扭、防飞溅 Torsion, welding spark resistant			154 054			
3 电缆长度 Cable length						
0.3m						
0.6m						
1.0m						
1.5m						
2.0m						

P-03 M12 圆形连接器 ROUND PLUG CONNECTOR

双端预铸线束
Connection cable

-M12-M12

屏蔽
Shielded

插针 Male
直出 Straight

插孔 Female
直出 Straight



1 型号 Form No.				
食品和饮料 FOOD & BEVERAGE	940481F	940501F	940521F	948041F
极数 Suppression	3-pole	4-pole	5-pole	8-pole

插针 Male
直出 Straight

插孔 Female
90°



型号 Form No.				
食品和饮料 FOOD & BEVERAGE	944121F	944131F	944141F	948181F
极数 Suppression	3-pole	4-pole	5-pole	8-pole

电路图
Circuit diagram

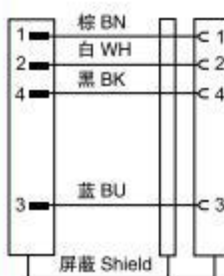
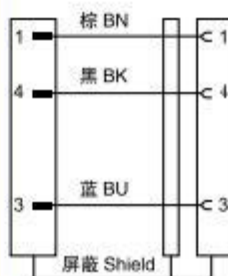

针脚排序
Contact layout

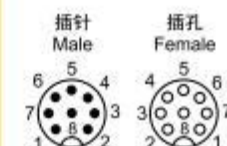
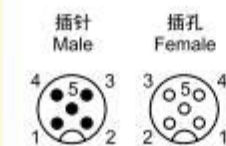
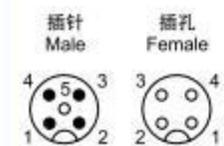
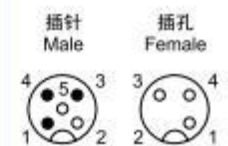

2 电缆类型 Cable type	护套颜色 Jacket color			
导体横截面 0.34mm ²	灰 GY	灰 GY	灰 GY	
PVC	317	330	348	
PUR	318	331	349	
导体横截面 0.25mm ²				黑 BK 灰 GY
PVC				294
PUR				297

3 电缆长度 Cable length
0.3m
0.6m
1.0m
1.5m
2.0m

P-03 M12 圆形连接器 ROUND PLUG CONNECTOR

单端预铸线束
With open ended wires

-M12-2 自由端
- The free end M12-2

插针 Male
Y 形直出 Distributor

自由端 The free end



1 型号 Form No.

食品和饮料 FOOD & BEVERAGE

940941F

940901F

极数
Suppression

3-pole

4-pole

电路图
Circuit diagram



针脚排序
Contact layout

Y- 插针
Y-Male



Y- 插针
Y-Male



2 电缆类型 Cable type

导体横截面 0.34mm²

PVC

PUR

PUR 高柔性 Highly flexible

抗扭、防飞溅 Torsion, welding spark resistant

护套颜色 Jacket color

灰 GY

黑 BK

黄 YE

橙 OG

灰 GY

黑 BK

213

613

223

623

224

624

633

154

054

634

3 电缆长度 Cable length

0.3m

0.6m

1.0m

1.5m

2.0m

P-03 M12 圆形连接器 ROUND PLUG CONNECTOR

双端预铸线束
Connection cable

-M12-2M12

插针 Male
Y形直出 Distributor

插孔 Female
直出 Straight



1 型号 Form No.

食品和饮料 FOOD & BEVERAGE
极数 Suppression

940701F
3-pole

940721F
4-pole

插针 Male
Y形直出 Distributor

插孔 Female
90°



型号 Form No.

食品和饮料 FOOD & BEVERAGE
极数 Suppression

940741F
3-pole

940761F
4-pole

电路图
Circuit diagram



针脚排序
Contact layout



2 电缆类型 Cable type

导体横截面 0.34mm²

PVC

PUR

PUR 高柔性 Highly flexible

抗扭、防飞溅 Torsion, welding spark resistant

护套颜色 Jacket color

灰 GY	黑 BK	黄 YE	橙 OG	灰 GY	黑 BK
213	613			214	614
223	623			224	624
	633				634
		154	054		

3 电缆长度 Cable length

0.3m

0.6m

1.0m

1.5m

2.0m

P-03 M12 圆形连接器 ROUND PLUG CONNECTOR

双端预铸线束
Connection cable

-M12-2M12
-M12-2M8

M12
插针 Male
Y形直出 Distributor



M12
插孔 Female
90° with LED

M12
插针 Male
Y形直出
Distributor

M8
插孔 Female
90°



P

1 型号 Form No.	940781F		940801F		940861F	
食品和饮料 FOOD & BEVERAGE	940781F		940801F		940861F	
极数 Suppression	3-pole带2xLED(PNP) 3-pole with 2 x LED (PNP)		4-pole带2xLED(PNP) 4-pole with 2 x LED (PNP)		3-pole带2xLED(PNP) 3-pole with 2 x LED (PNP)	
电路图 Circuit diagram						
针脚排序 Contact layout						
2 电缆类型 Cable type	护套颜色 Jacket color				芯线直径 Wire 0.25mm ²	
导体横截面	灰 GY	黑 BK	黄 YE	灰 GY	黑 BK	黄 YE
PVC	213	613		214	614	210
PUR	223	623		224	624	220
PUR 高柔性 Highly flexible		633			634	
抗扭、防飞溅 Torsion, welding spark resistant			154 054			150 050
3 电缆长度 Cable length	0.3m					
	0.6m					
	1.0m					
	1.5m					
	2.0m					

P-03 M12 圆形连接器 ROUND PLUG CONNECTOR

双端预铸线束
Connection cable
-M12-2M8

M12
插针 Male
Y形直出 Distributor

M8
插孔 Female
直出 Straight

M12
插针 Male
Y形直出 Distributor

M8
插孔 Female
90°



1 型号 Form No.

食品和饮料 FOOD & BEVERAGE

极数

Suppression

电路图

Circuit diagram



针脚排序

Contact layout

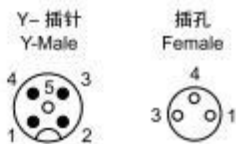

2 电缆类型 Cable type

导体横截面 0.25mm²

PVC

PUR

PUR 高柔性 Highly flexible

抗扭、防飞溅 Torsion, welding spark resistant

护套颜色 Jacket color

黄 YE

灰 GY

黑 BK

黄 YE

灰 GY

黑 BK

210

220

610

210

220

610

620

630

620

620

630

630

150

050

150

050

150

050

150

050

150

050

150

050

3 电缆长度 Cable length

0.3m

0.6m

1.0m

1.5m

2.0m

P-03 M12 圆形连接器 ROUND PLUG CONNECTOR

双端预铸线束
Connection cable
-M12-2M12

插针 Male
Y形直出 Distributor

插孔 Female
直出 Straight



1 型号 Form No.

食品和饮料 FOOD & BEVERAGE
极数 Suppression

940752F
3-pole

940753F
4-pole

电路图
Circuit diagram



针脚排序
Contact layout

Y-插针
Y-Male

插孔
Female



Y-插针
Y-Male

插孔
Female



2 电缆类型 Cable type

导体横截面 0.34mm²

PVC

PUR

PUR 高柔性 Highly flexible

抗扭、防飞溅 Torsion, welding spark resistant

护套颜色 Jacket color

黄 YE

橙 OG

灰 GY

黑 BK

214

224

614

624

154

054

634

3 电缆长度 Cable length

0.3m

0.6m

1.0m

1.5m

2.0m

P-03 板后安装连接器 PLATE CONNECTOR AFTER INSTALLATION

带线板后安装
Pre-wired installation

M12 插针 Male



M12 插孔 Female



1 极数 Suppression	4-pole	5-pole	8-pole	4-pole	5-pole	8-pole
针脚排序 Contact layout	插针 Male 	插针 Male 	插针 Male 	插孔 Female 	插孔 Female 	插孔 Female
额定电压 Supply voltage	250 V AC/DC	125 V AC/DC	60 V AC/DC	250 V AC/DC	125 V AC/DC	60 V AC/DC
额定电流 Current per contact (40°C)	4A	4A	2A	4A	4A	2A
针脚排序 Contact layout	插针 Male 	插针 Male 		插孔 Female 	插孔 Female 	
额定电压 Supply voltage	250 V AC/DC	125 V AC/DC		250 V AC/DC	125 V AC/DC	
额定电流 Current per contact (40°C)	4A	4A		4A	4A	
针脚排序 Contact layout	插针 Male 			插孔 Female 		
额定电压 Supply voltage	250 V AC/DC			250 V AC/DC		
额定电流 Current per contact (40°C)	4A			4A		
电路图 Circuit diagram	<ul style="list-style-type: none"> 1 棕 BN 2 白 WH 4 黑 BK 3 蓝 BU 	<ul style="list-style-type: none"> 1 棕 BN 2 白 WH 4 黑 BK 3 蓝 BU 5 灰 GY 	<ul style="list-style-type: none"> 1 白 WH 2 棕 BN 3 绿 GN 4 黄 YE 5 灰 GY 6 粉 PK 7 蓝 BU 8 红 RD 	<ul style="list-style-type: none"> 1 棕 BN 2 白 WH 4 黑 BK 3 蓝 BU 	<ul style="list-style-type: none"> 1 棕 BN 2 白 WH 4 黑 BK 3 蓝 BU 5 灰 GY 	<ul style="list-style-type: none"> 1 白 WH 2 棕 BN 3 绿 GN 4 黄 YE 5 灰 GY 6 粉 PK 7 蓝 BU 8 红 RD

2 技术参数 Technical data

防护等级 Protection	IP67- 插孔插针配合拧紧 (EN 60529) When plugged and screwed down
导体截面积 Connection diameter	0.25 mm ²
温度范围 Temperature range	- 25...+ 85 °C

3 螺母固定 Suitable mounting nut 默认为 M16 螺母: 971 (M16), 量大可选: 974(M12), 977(PG9), 制作带 T 料号需有对应规格书。

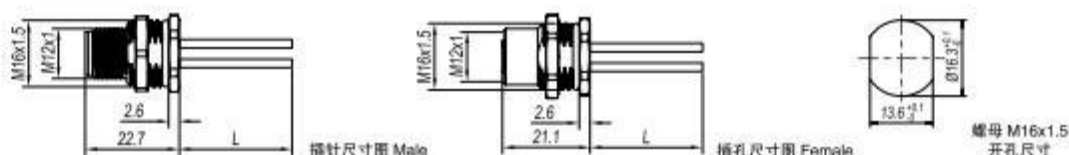
尺寸图
Description

P-03 板前安装连接器 BEFORE INSTALL THE CONNECTOR

带线板前安装
Pre-wired installation

1 极数 Suppression	4-pole	5-pole	8-pole	4-pole	5-pole	8-pole
针脚排序 Contact layout	插针 Male 	插针 Male 	插针 Male 	插孔 Female 	插孔 Female 	插孔 Female
额定电压 Supply voltage	250 V AC/DC	125 V AC/DC	60 V AC/DC	250 V AC/DC	125 V AC/DC	60 V AC/DC
额定电流 Current per contact (40°C)	4A	4A	2A	4A	4A	2A
针脚排序 Contact layout	插针 Male 	插针 Male 		插孔 Female 	插孔 Female 	
额定电压 Supply voltage	250 V AC/DC	125 V AC/DC		250 V AC/DC	125 V AC/DC	
额定电流 Current per contact (40°C)	4A	4A		4A	4A	
针脚排序 Contact layout	插针 Male 			插孔 Female 		
额定电压 Supply voltage	250 V AC/DC			250 V AC/DC		
额定电流 Current per contact (40°C)	4A			4A		
电路图 Circuit diagram	 1 棕 BN 2 白 WH 4 黑 BK 3 蓝 BU	 1 棕 BN 2 白 WH 4 黑 BK 3 蓝 BU 5 灰 GY	 1 白 WH 2 棕 BN 3 绿 GN 4 黄 YE 5 灰 GY 6 粉 PK 7 蓝 BU 8 红 RD	 1 棕 BN 2 白 WH 4 黑 BK 3 蓝 BU	 1 棕 BN 2 白 WH 4 黑 BK 3 蓝 BU 5 灰 GY	 1 白 WH 2 棕 BN 3 绿 GN 4 黄 YE 5 灰 GY 6 粉 PK 7 蓝 BU 8 红 RD

2 技术参数 Technical data

防护等级 Protection	IP67- 插孔插针配合拧紧 (EN 60529) When plugged and screwed down
导体截面积 Connection diameter	0.25 mm ²
温度范围 Temperature range	- 25...+ 85 °C

3 螺母固定 Suitable mounting nut 默认为 M16 螺母: 971 (M16), 量大可选: 974(M12), 977(PG9), 979(M20), 制作带 T 料号需有对应规格书。

尺寸图 Description

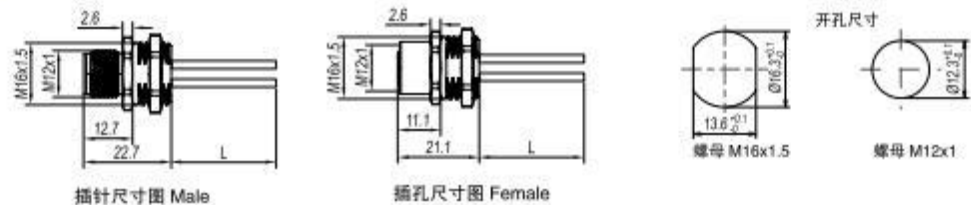

电缆长度单位: cm 电缆类型没有标注的默认为不带线的焊线结构。

P-03 板后安装连接器 CONNECTOR

P



M12 插针 Male



M12 插孔 Female



1 极数 Suppression	4-pole	5-pole	8-pole	4-pole	5-pole	8-pole
针脚排序 Contact layout	插针 Male 	插针 Male 	插针 Male 	插孔 Female 	插孔 Female 	插孔 Female
针脚排序 Contact layout	插针 Male 	插针 Male 		插孔 Female 	插孔 Female 	
针脚排序 Contact layout	插针 Male 			插孔 Female 		

2 螺母固定 Suitable mounting nut 默认为 M16 螺母: 971 (M16), 量大可选: 974(M12), 977(PG9), 制作带 T 料号需有对应规格书。

尺寸图 Description

插针尺寸图 Male

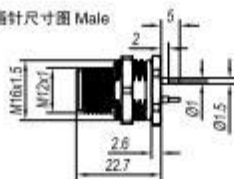

插孔尺寸图 Female

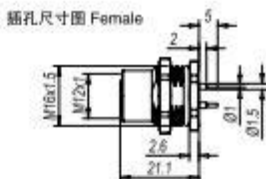

开孔尺寸

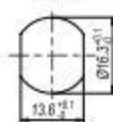
螺母 M16x1.5
开孔尺寸

螺母 M12x1

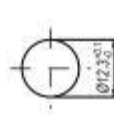

PCB 焊接型



现场接线焊接型

P-03 板前安装连接器 CONNECTOR

M12 插针 Male



M12 插孔 Female



1 极数 Suppression	4-pole	5-pole	8-pole	4-pole	5-pole	8-pole
针脚排序 Contact layout	插针 Male 	插针 Male 	插针 Male 	插孔 Female 	插孔 Female 	插孔 Female
针脚排序 Contact layout	插针 Male 	插针 Male 		插孔 Female 	插孔 Female 	
针脚排序 Contact layout	插针 Male 			插孔 Female 		
2 螺母固定 Suitable mounting nut	默认为 M16 螺母: 971 (M16), 量大可选: 974(M12), 977(PG9), 制作带 T 料号需有对应规格书。					

尺寸图 Description

M12 插针 Male

M12 插孔 Female

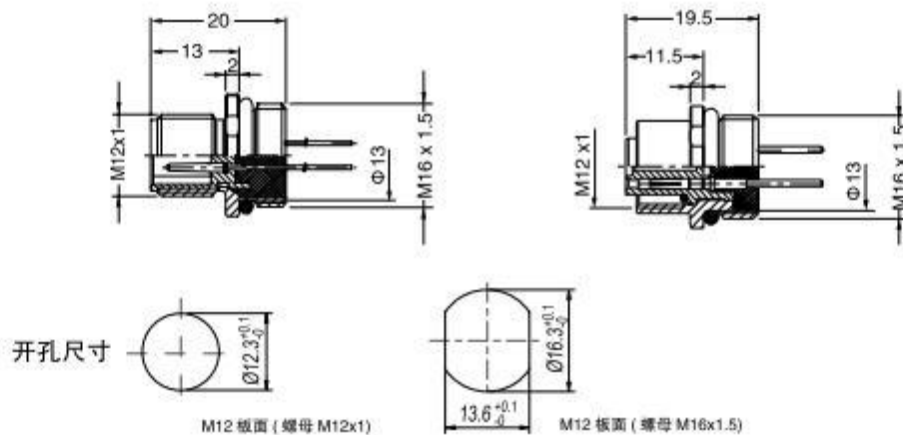

电缆长度单位: cm 电缆类型没有标注的默认为不带线的焊线结构。

P-03 PCB 安装连接器 INSTALL THE CONNECTOR FOR

P



M12 插针 Male



M12 插孔 Female



1 极数 Suppression	4-pole	5-pole	4-pole	5-pole
针脚排序 Contact layout	插针 Male 	插针 Male 	插孔 Female 	插孔 Female
针脚排序 Contact layout	插针 Male 	插针 Male 	插孔 Female 	插孔 Female
技术参数 Technical data	250 V AC/DC	125 V AC/DC	250 V AC/DC	125 V AC/DC
额定电压 Supply voltage	250 V AC/DC	125 V AC/DC	250 V AC/DC	125 V AC/DC
额定电流 Current per contact (40°C)	4A			
防护等级 Protection	IP67-插孔插针配合拧紧(EN 60529) When plugged and screwed down			
拔插寿命(次) Pull out plug life (time)	≥ 100			
温度范围 Temperature range	-25...+85°C			
针脚排序 Contact layout	插针 Male 		插孔 Female 	
技术参数 Technical data	250 V AC/DC			
额定电压 Supply voltage	250 V AC/DC			
额定电流 Current per contact (40°C)	4A			
防护等级 Protection	IP67-插孔插针配合拧紧(EN 60529) When plugged and screwed down			
拔插寿命(次) Pull out plug life (time)	≥ 100			
温度范围 Temperature range	-25...+85°C			

尺寸图 Description

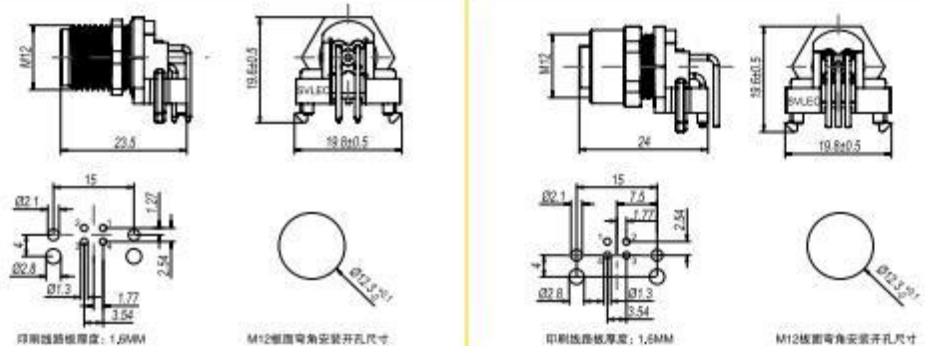

P-03 板面安装连接器 PANEL INSTALLED CONNECTORS

面板引入连接器
Control cabinet entry system
屏蔽 Shielded

M12 插针 / 插孔 Male /Female



1 型号 Form No.

极数 Suppression	5-pole	5-pole, B-coded	4-pole, D-coded	8-pole
电路图 Circuit diagram				
针脚排序 Contact layout				

2 技术参数 Technical data

额定电压 Supply voltage	125 V AC/DC
额定电流 Current per contact (40°C)	4A
防护等级 Protection	IP67-插孔插针配合拧紧(EN 60529) When plugged and screwed down
温度范围 Temperature range	-25...+85°C

尺寸图 Description

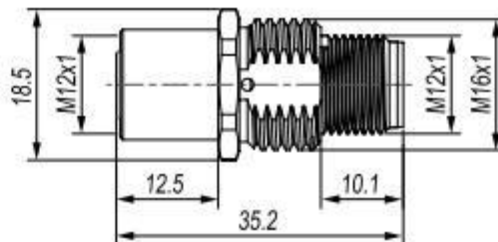

开孔尺寸

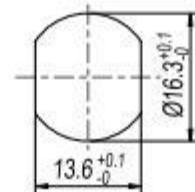

螺母 M16x1.5

P-03 附件 ACCESSORIES

电缆标识附件 Labeling accessories		适用范围 Suitable for
	M8 母头塑料保护盖 Plastic screw plug	
	M12 公头塑料保护盖 Male blind plug (Plastic) M12 母头塑料保护盖 Female blind plug (Plastic)	
	滑动电缆套管 Slip-on cable sleeves 4x18 mm	电缆直径 4.0...6.5 mm Cable diameter 4.0...6.5 mm
	可拆卸电缆套管 Snap-on cable sleeves 4x18 mm	电缆直径 4.2...7.0 mm Cable diameter 4.2...7.0 mm
	标识板 Label plates 4x18 mm	
	M12 连接器预铸线安装扳手	
	M12 连接器现场接线安装扳手	

连接器固定器

名称 Identification	型号 Type	应用图
SHD 连接器固定器 适用于 M8 预铸线 M4 螺丝	SHD 8 4	 M8 预铸线
SHD 连接器固定器 适用于 M8 现场接线与 M12 预铸线 M4 螺丝	SHD 12 4	 M8 现场接线 M12 预铸线

客户订制 Custom customization

- M12 Y 型直出 - 2M12 插孔直出



P-04 Y T型连接器 ROUND PLUG CONNECTOR

Y型连接器 Connection cable



M12 双孔连接器
M12 插针 Male
M12 插孔 Female

页次 page 3.3.1

Y型连接器 Connection cable



1 端口 Coupler
M12 插针 Male
M12 插孔 Female

2 端口 Coupler
M12 插孔 Female
M12 插针 Male

页次 page 3.3.2



1 端口 Coupler
M12 插针 Male

2 端口 Coupler
M8 插孔 Female

页次 page 3.3.3



1 端口 Coupler
M8 插针 Male

2 端口 Coupler
M8 插孔 Female

页次 page 3.3.4

T型连接器 Connection cable



1 端口 Coupler
M12 插孔 Female

2 端口 Coupler
M12 插针 Male
M12 插孔 Female



M12 插针 Male

M12 插针 Male
M12 插孔 Female

页次 page 3.3.5



1 端口连接器 Power distributor
M12 插孔 Female

2 端口连接器 Power distributor
7/8" 插针 Male
7/8" 插孔 Female



7/8" 插孔 Female

7/8" 插针 Male
7/8" 插孔 Female

P-04 M12 双孔连接器 CONNECTION

M12 螺钉连接

插针 Male
双出线孔插针 Male
单出线孔

1 型号 Form No.

极数
Suppression

4-pole

4-pole

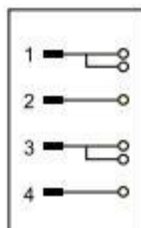

出线孔位图

针脚排序
Contact layout注：
1号和3号角位可以同时满足各接两根电源线

2 技术参数 Technical data

用于连接两根电缆的电缆直径	5.2-3.5 mm	4-8 mm
额定电压 Supply voltage	60 V AC/DC	
额定电流 Current per contact (40°C)	max. 4 A	
压线范围 Connection diameter	最大 max. 0.75 mm ²	
外壳材料 Housing material	阻燃塑料 Flame retardant plastic	
压线方式 Wiring method	螺钉压接 Screw terminals	
防护等级 Protection	IP67- 插孔插针配合拧紧 (EN 60529) When plugged and screwed down	
温度范围 Temperature range	-25...+85°C	
针脚定义 Contact layout	1号脚与3号脚为电源线针，每根针上面可以接两根电源线，2号脚与4号脚分别接一根信号线	

尺寸图 Description

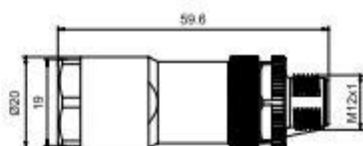

P-04 M12 Y 型连接器 CONNECTION

M12-2M12

M12 插孔 Female x 2



M12 插针 Male

M12 插针 Male x 2



M12 插孔 Female

1 型号 Form No.

无 5 号脚 without pin5

电路图
Circuit diagram

1. 插孔 M12 2. 插孔
1.Female 2.Female

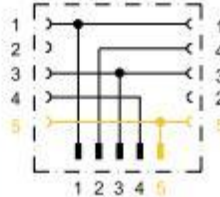

M12 插针
Male

1. 插孔 M12 2. 插孔
1.Female 2.Female

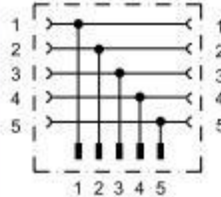

M12 插针
Male

1. 插孔 M12 2. 插孔
1.Female 2.Female

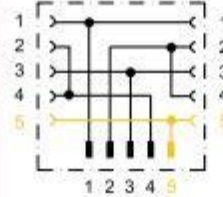

M12 插针
Male

1. 插针 M12 2. 插针
1.Male 2.Male

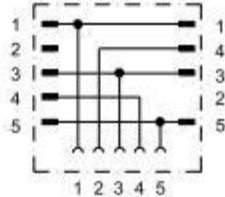

M12 插孔
Female

针脚排序
Contact layout

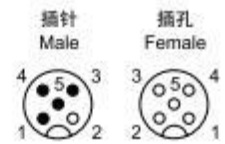
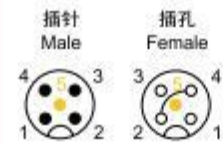
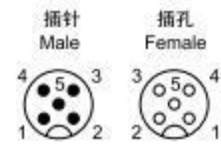
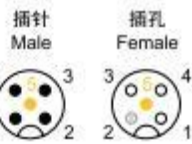

2 电缆类型 Cable type

额定电压
Supply voltage 60 V AC/DC

额定电流 (40°C)
Current per contact max. 4A

防护等级
Protection IP67- 插孔插针配合拧紧 (EN 60529) IP67 when plugged and screwed down

温度范围
Temperature range -25...+85°C

外形尺寸 H x W x D
Dimensions 44 x 36 x 15 mm

47 x 36 x 15 mm

尺寸图 Description

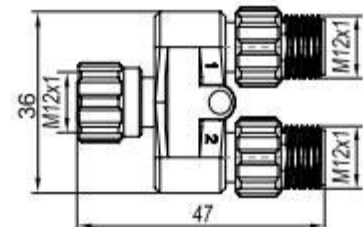
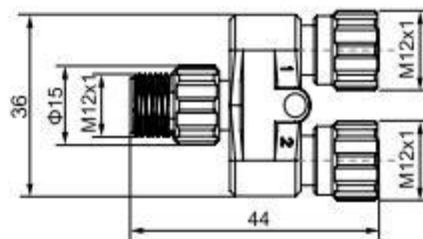

P-04 M12 Y 型连接器 CONNECTION

M12-2M8

M8 插孔 Female x 2



M12 插针 Male

1 型号 Form No.

极数
Suppression

4-pole

3-pole

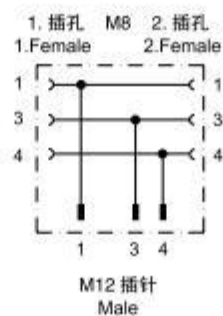
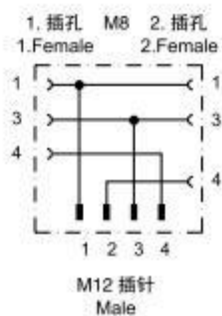
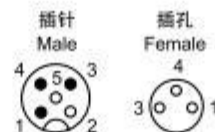
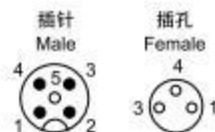
电路图
Circuit diagram针脚排序
Contact layout

2 电缆类型 Cable type

额定电压
Supply voltage 30 V AC/DC额定电流 (40°C)
Current per contact max. 4A防护等级
Protection IP67- 插孔插针配合拧紧 (EN 60529) IP67 when plugged and screwed down温度范围
Temperature range -25...+85°C外形尺寸 H x W x D
Dimensions 42 x 36 x 15 mm

尺寸图 Description

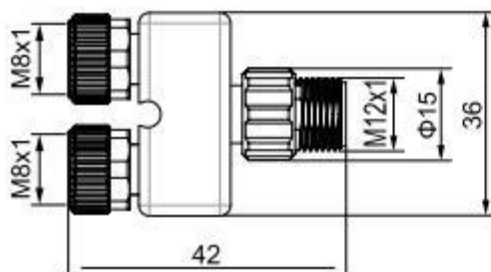

P-04 M8 Y 型连接器 CONNECTION

M8-2M8

M8 插孔 Female x 2



M8 插针 Male

1 型号 Form No.				
极数 Suppression	3-pole	3-pole	4-pole	4-pole
电路图 Circuit diagram	<p>A. 插孔 A.Female M8 B. 插孔 B.Female</p> <p>M8 插针 Male</p>	<p>A. 插孔 A.Female M8 B. 插孔 B.Female</p> <p>M8 插针 Male</p>	<p>A. 插孔 A.Female M8 B. 插孔 B.Female</p> <p>M8 插针 Male</p>	<p>A. 插孔 A.Female M8 B. 插孔 B.Female</p> <p>M8 插针 Male</p>
针脚排序 Contact layout	<p>插针 Male 插孔 Female</p>	<p>插针 Male 插孔 Female</p>	<p>插针 Male 插孔 Female</p>	<p>插针 Male 插孔 Female</p>
2 电缆类型 Cable type				
额定电压 Supply voltage	30 V AC/DC			
额定电流 (40°C) Current per contact	max. 2A			
防护等级 Protection	IP67- 插孔插针配合拧紧 (EN 60529) IP67 when plugged and screwed down			
温度范围 Temperature range	-25...+85°C			
外形尺寸 H x W x D Dimensions	33 x 23 x 10 mm			
尺寸图 Description				

P-04 T 型连接器 CONNECTION

M12-2M12

M12
插针 MaleM12 插孔
FemaleM12 T-code
插针 MaleM12 T-code
插孔 Female屏蔽 Shield
M12 插针 MaleM12 插孔
Female

M12 插孔 Female

M12 T-code
插孔 Female

M12 插针 Male

1 型号 Form No.

极数
Suppression

5-pole

4-pole

5-pole

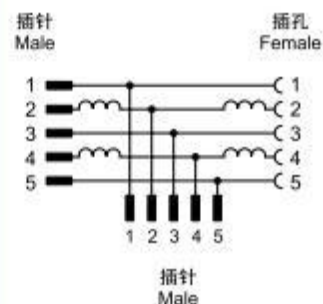
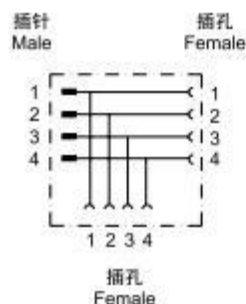
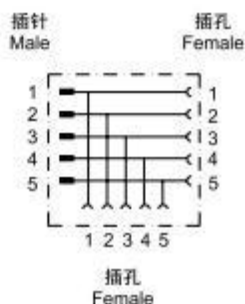
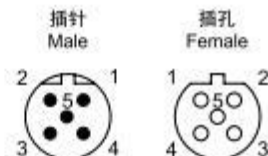
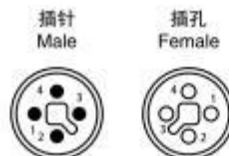
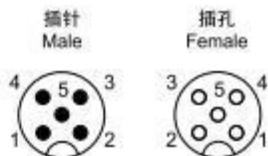
电路图
Circuit diagram针脚排序
Contact layout

2 电缆类型 Cable type

额定电压
Supply voltage

60 V AC/DC

63 V AC/DC

60 V AC/DC

额定电流 (40°C)
Current per contact

max. 4A

max. 12A

max. 4A

防护等级
Protection

IP67- 插孔插针配合拧紧 (EN 60529) IP67 when plugged and screwed down (EN 60529)

温度范围
Temperature range

-25...+85°C

尺寸图 Description

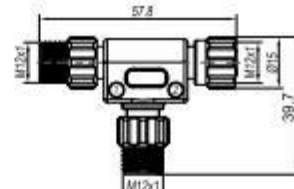
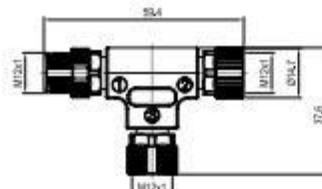
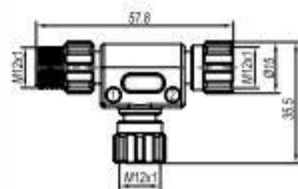

P-04 T型连接器 CONNECTION

DeviceNet 通讯
DeviceNet communications

7/8" 插针 Male
7/8" 插孔 Female



M12 插孔 Female

7/8" 插针 Male

7/8" 插孔 Female



7/8" 插孔 Female

1 型号 Form No.

极数

5-pole

3-pole

4-pole

5-pole

Suppression

电路图

Circuit diagram

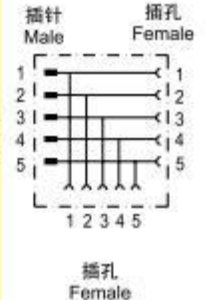
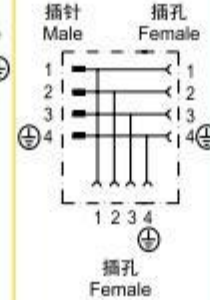
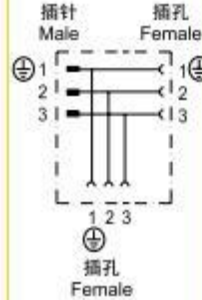
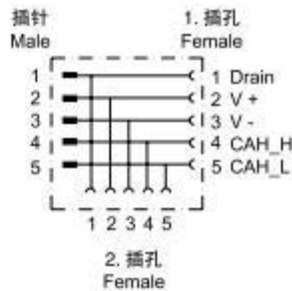

针脚排序

Contact layout

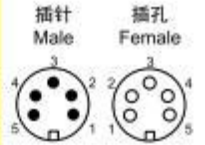
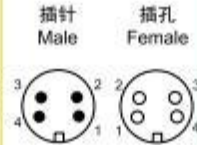
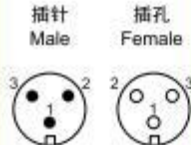
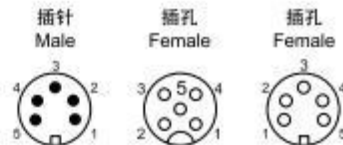

2 电缆类型 Cable type

额定电压

Supply voltage

250 V AC/DC

600 V AC/DC

额定电流 (40°C)

Current per contact

max. 4A

max. 13A

max. 10A

max. 8A

防护等级

Protection

IP67- 插孔插针配合拧紧 (EN 60529) IP67 when plugged and screwed down (EN 60529)

温度范围

Temperature range

-25...+85°C

尺寸图 Description

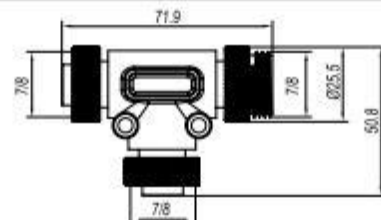
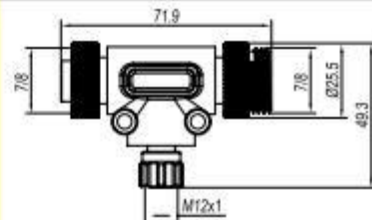

P-05 传感器 / 执行机构分配器 For sensors and actuators

分配器定义 Distribution systems

SCAB - M8 - 12C - 1 - P - 5.0 - PUR / PCB - E

系列号 Series

规格 Specification

M8
M8S = M8 窄系列
M12
7/8"

端口 Way

4 = 4 端口
6 = 6 端口
8 = 8 端口
12 = 12 端口

电源 Power

1 = 单电源单通道
2 = 单电源双通道
3 = 双电源双通道

线缆材质 Cable material

PVC = 固定
PUR = 拖链

带线长度 Cable length

0.3 = 0.3m
0.5 = 0.5m
1.0 = 1.0m

Polarity 极性

P = PNP
N = NPN

E = 带插头
空白 = 不带插头

不带线
M12
M23
PCB
D-SUB

M8 分配器安装尺寸 Distribution systems

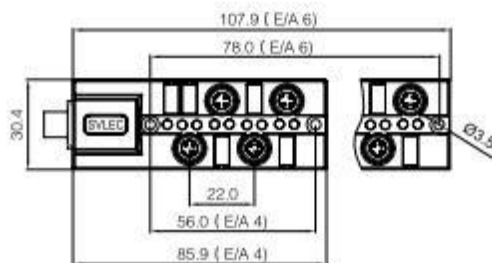
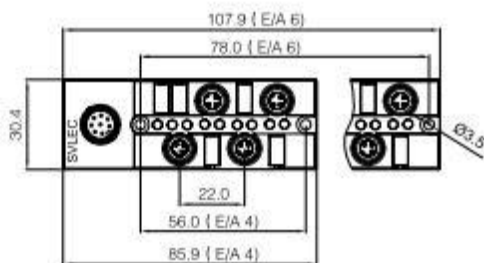
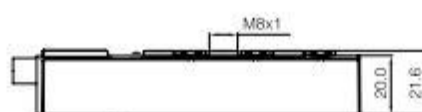
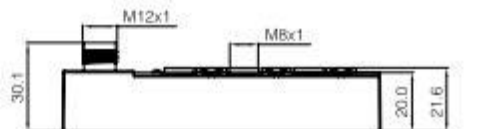

现场接线 Field-wireable

预铸线 Pre-cast line

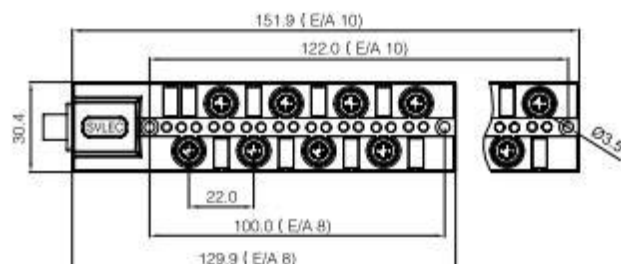
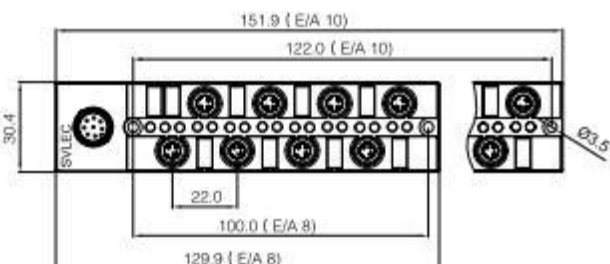
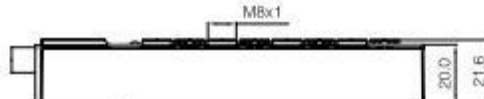
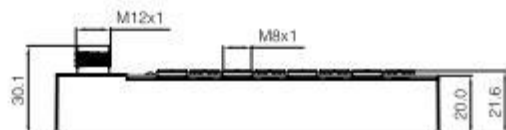

现场接线 Field-wireable

预铸线 Pre-cast line

P-05 分配器技术参数 TECHNICAL DATA - DISTRIBUTION SYSTEMS

M8 分配器安装尺寸 Distribution systems

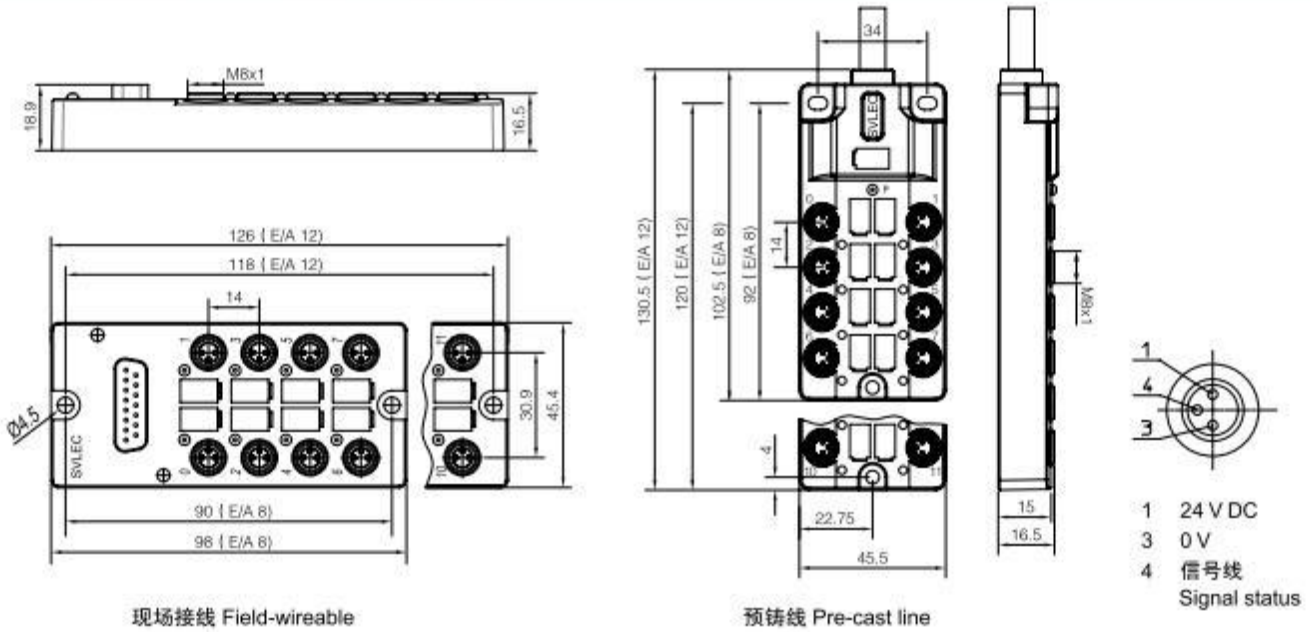

M12 分配器安装尺寸 Distribution systems

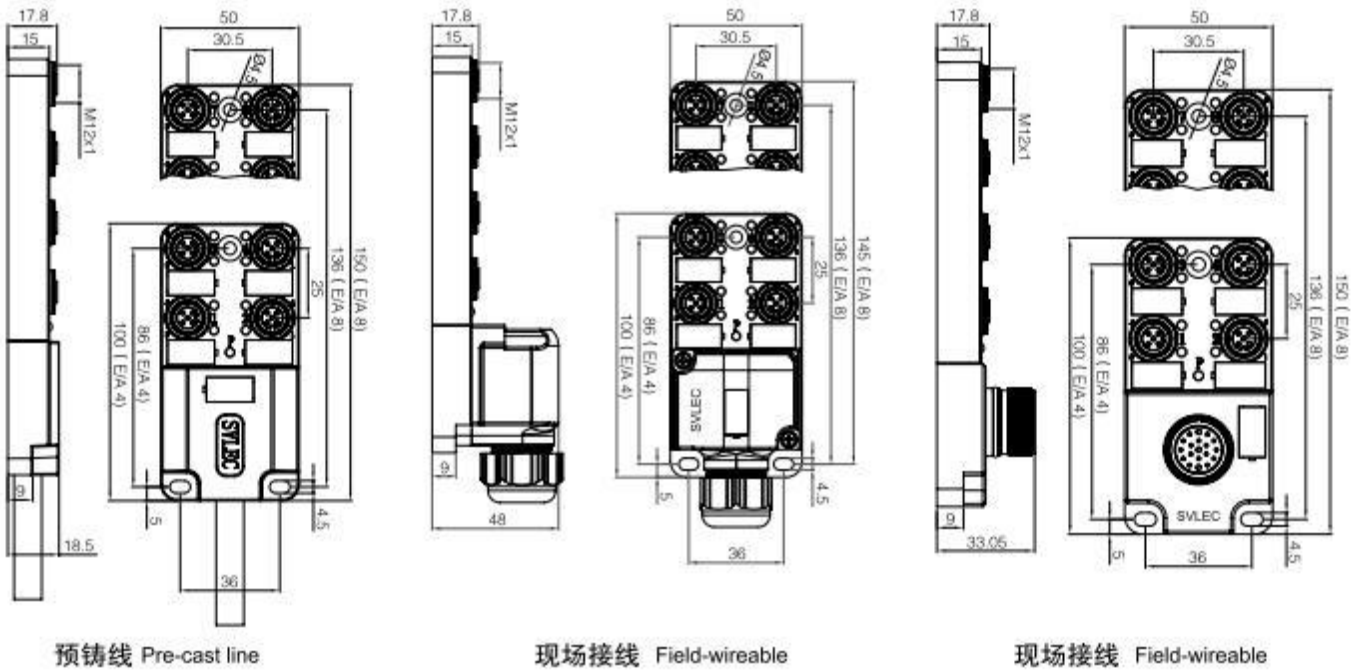

分配器插头外形尺寸 Distributor plug size shape

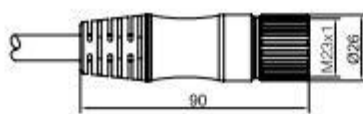

M12 分配器插头 直出线 Straight

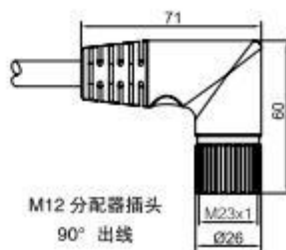

M12 分配器插头 90° 出线

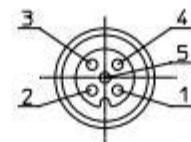

- 1 24 V DC
- 2 n.c.
- 3 0 V
- 4 信号线 Signal status
- 5 接地 Ground wire

P-05 M8 分配器 – 预铸电缆 DISTRIBUTION SYSTEMS

无卤电缆 PUR
Halogen free cable PUR

or PUR/PVC

单通道

1 signal per port

4 端口 Way



6 端口 Way



1 型号 Form

PNP

NPN

电路图

Circuit diagram

引脚定义:

Contact layout

Pin 1: (+)

Pin 3: (-)

Pin 4: (S1)

LED 显示: 电源 (绿)

LED indicator: green, power

信号 S1 (黄)

yellow, signal

M8 插孔 Female
3-pole

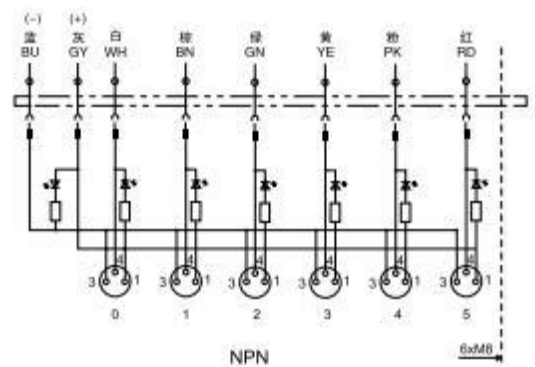
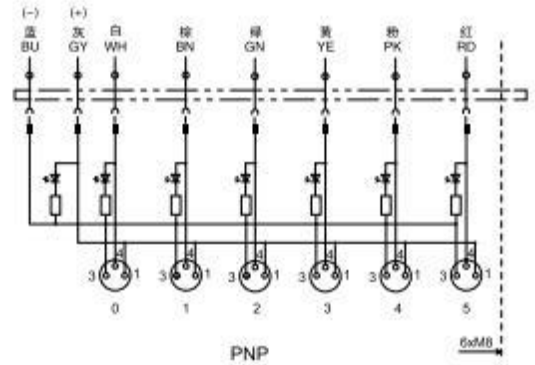
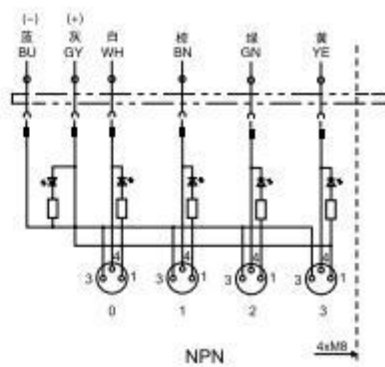
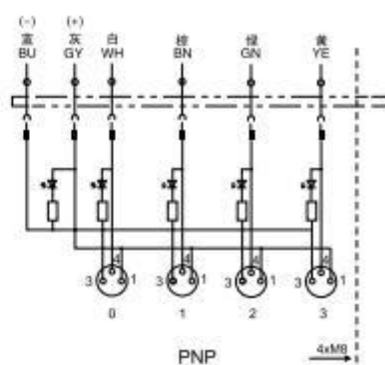

2 电缆类型 Cable type

电缆线经 Wires

PVC

PUR

灰 GY

$4 \times 0.25 + 2 \times 0.5\text{mm}^2$

$4 \times 0.25 + 2 \times 0.5\text{mm}^2$

灰 GY

$6 \times 0.25\text{mm}^2 + 2 \times 0.5\text{mm}^2$

3 电缆长度 Cable length

3.0 m

5.0 m

10.0 m

15.0 m

P-05 M8 分配器 – 预铸电缆 DISTRIBUTION SYSTEMS

无卤电缆 PUR
Halogen free cable PUR
or PUR/PVC

单通道
1 signal per port

8 端口 Way



10 端口 Way



1 型号 Form

PNP
NPN

电路图
Circuit diagram

针脚定义:
Contact layout

Pin 1: (+)
Pin 3: (-)
Pin 4: (S1)

LED 显示: 电源 (绿)
LED indicator: green, power
信号 S1 (黄)
yellow, signal

M8 插孔 Female
3-pole

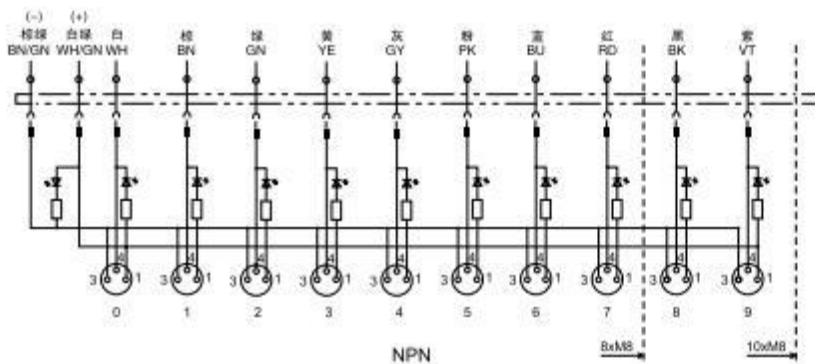
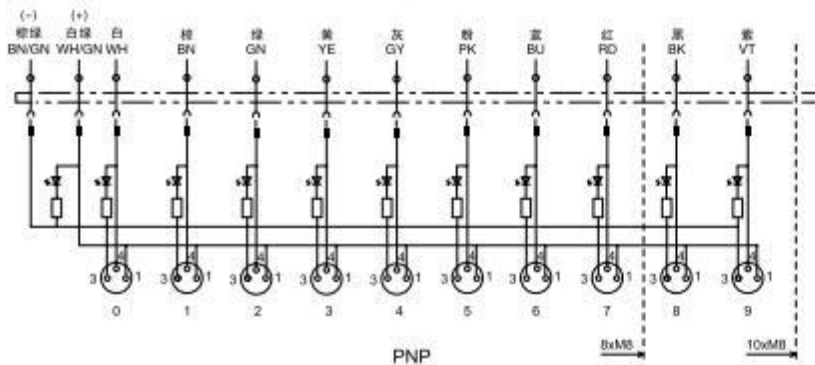

2 电缆类型 Cable type

电缆线径 Wires

	灰 GY	灰 GY
PVC	$8 \times 0.25 + 2 \times 0.5\text{mm}^2$	$12 \times 0.25 + 2 \times 0.5\text{mm}^2$
PUR	$8 \times 0.25 + 2 \times 0.5\text{mm}^2$	$12 \times 0.25 + 2 \times 0.5\text{mm}^2$
低温	$8 \times 0.25 + 2 \times 0.5\text{mm}^2$	

3 电缆长度 Cable length

3.0 m

5.0 m

10.0 m

15.0 m

P-05 M8 分配器 – 预铸电缆 DISTRIBUTION SYSTEMS

无卤电缆 PUR
Halogen free cable PUR
or PUR/PVC

单通道
1 signal per port

8 端口 Way



12 端口 Way



1 型号 Form

PNP
NPN

电路图
Circuit diagram

引脚定义:
Contact layout

Pin 1: (+)
Pin 3: (-)
Pin 4: (S1)

LED 显示: 电源 (绿)
LED indicator: green, power
信号 S1 (黄)
yellow, signal

M8 插孔 Female
3-pole

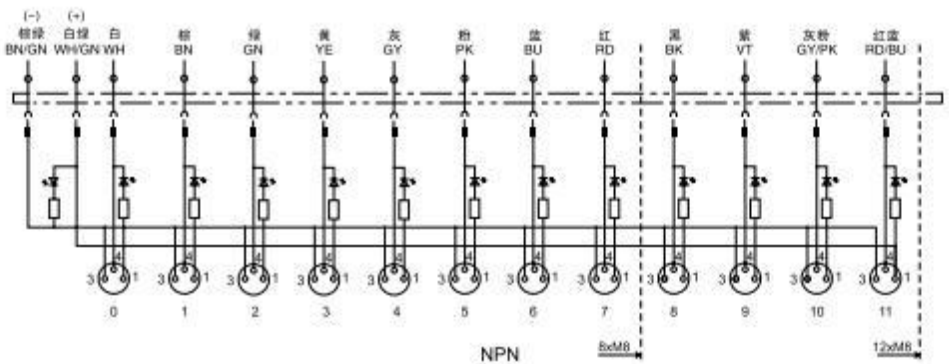
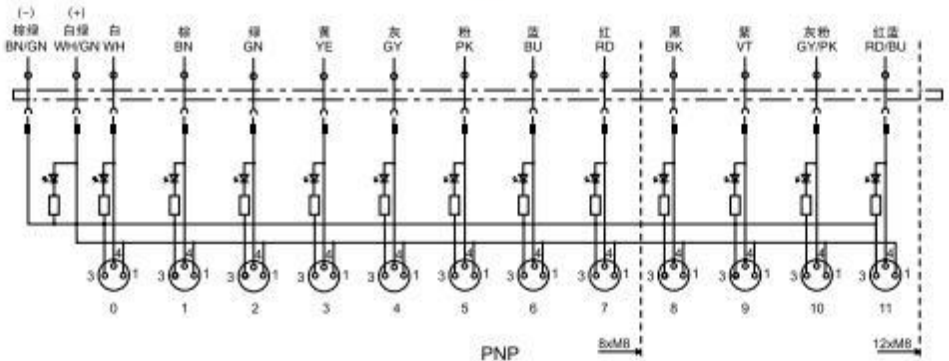

2 电缆类型 Cable type

电缆线经 Wires

	灰 GY	灰 GY
PVC	8 × 0.25 + 2 × 0.5mm ²	12 × 0.25 + 2 × 0.5mm ²
PUR	8 × 0.25 + 2 × 0.5mm ²	12 × 0.25 + 2 × 0.5mm ²

3 电缆长度 Cable length

3.0 m

5.0 m

10.0 m

15.0 m

P-05 M8 分配器 – 预铸电缆 DISTRIBUTION SYSTEMS

无卤电缆 PUR
Halogen free cable PUR
or PUR/PVC

双通道
2 signals per port

8 端口 Way



12 端口 Way



1 型号 Form

PNP
NPN

电路图
Circuit diagram

针脚定义:
Contact layout

Pin 1: (+)
Pin 2: (S2)
Pin 3: (-)
Pin 4: (S1)

LED 显示: 电源 (绿)
LED indicator: green, power
信号 S1 (蓝)
blue, signal
信号 S2 (红)
red, signal

M8 插孔 Female
4-pole

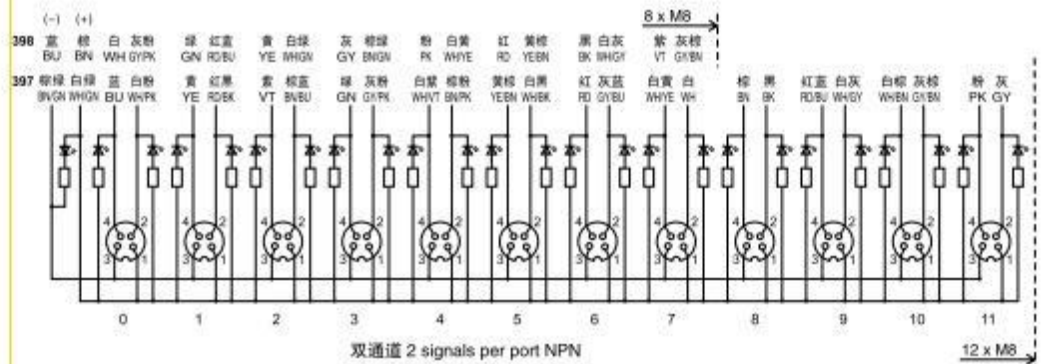
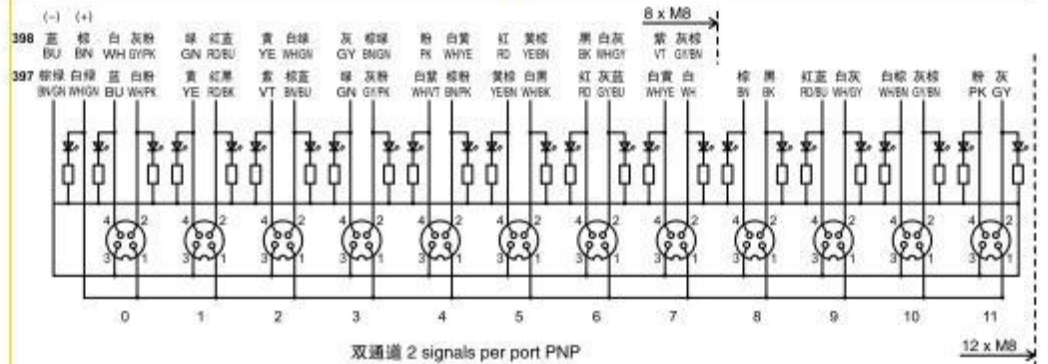

2 电缆类型 Cable type

电缆线经 Wires

PVC	灰 GY	灰 GY
PUR	$16 \times 0.34 + 3 \times 0.75\text{mm}^2$	$24 \times 0.25 + 2 \times 0.5\text{mm}^2$

3 电缆长度 Cable length

3.0 m

5.0 m

10.0 m

15.0 m

P-05 M8 分配器 DISTRIBUTION SYSTEMS

预制插头
Pre-cast connector

单通道
1 signal per port

4 端口 Way

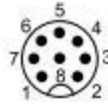

6 端口 Way

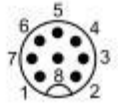

1 型号 Form

PNP
NPN



型号 Form

PNP
NPN

插头适用电缆直径 Homerun cable 6.0~8.0mm

电路图

Circuit diagram

引脚定义:
Contact layout

Pin 1: (+)
Pin 3: (-)
Pin 4: (S1)

LED 显示: 电源 (绿)
LED indicator: green, power
信号 S1 (黄)
yellow, signal

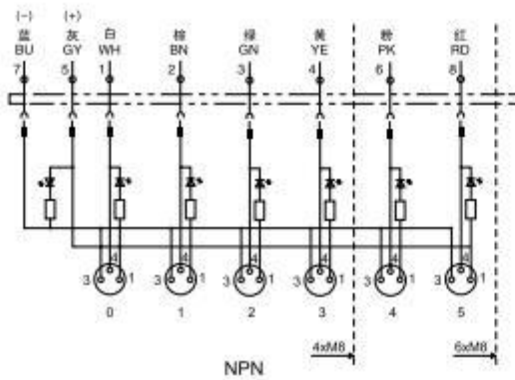
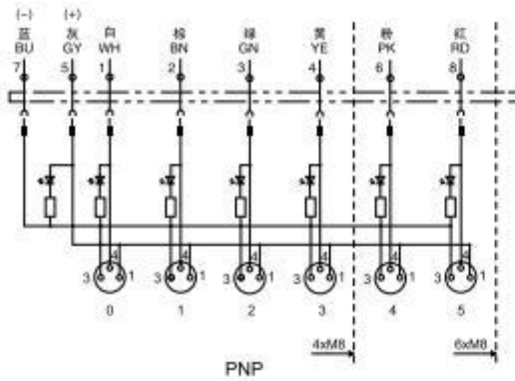

M8 插孔 Female
3-pole



备注 Notes

P-05 M8 分配器 DISTRIBUTION SYSTEMS

预制插头
Pre-cast connector

单通道
1 signal per port

8 端口 Way

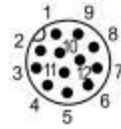

10 端口 Way

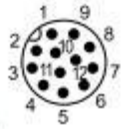

1 型号 Form

PNP	980805	981002
NPN	980803	981003

电路图
Circuit diagram

引脚定义:
Contact layout

Pin 1: (+)
Pin 3: (-)
Pin 4: (S1)

LED 显示: 电源 (绿)
LED indicator: green, power
信号 S1 (黄)
yellow, signal

M8 插孔 Female
3-pole

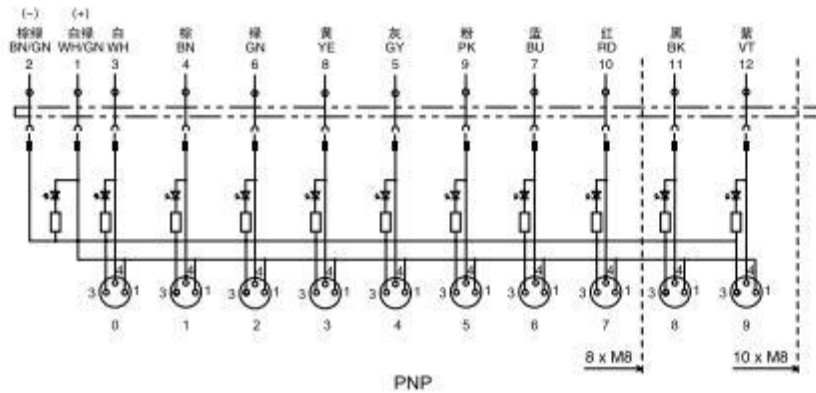

PNP

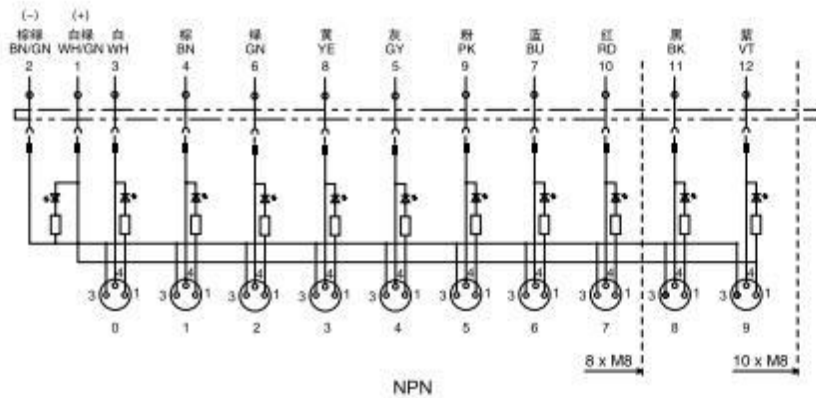

NPN

2 技术参数 Technical data

额定电压 Supply voltage	24 V DC (18...30.2V DC)
额定电流 Combined current	2A
防护等级 Protection	IP67
温度范围 Temperature range	-20...+70°C

P-05 M8 分配器 DISTRIBUTION SYSTEMS

预制插头
Pre-cast connector

单通道
1 signal per port

8 端口 Way

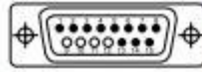

12 端口 Way

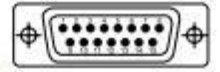

1 型号 Form

PNP
NPN



型号 Form

PNP
NPN

插头适用电缆直径 Homerun cable 6.0...12.0mm

电路图

Circuit diagram

引脚定义:
Contact layout

Pin 1: (+)
Pin 3: (-)
Pin 4: (S1)

LED 显示: 电源 (绿)
LED indicator: green, power
信号 S1 (黄)
yellow, signal

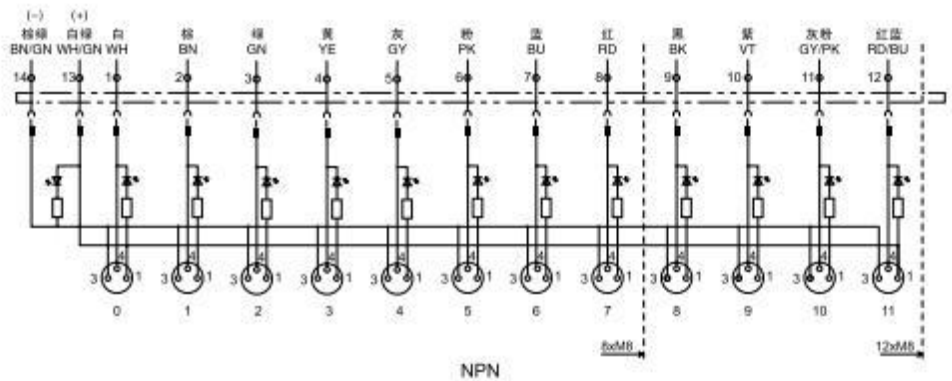
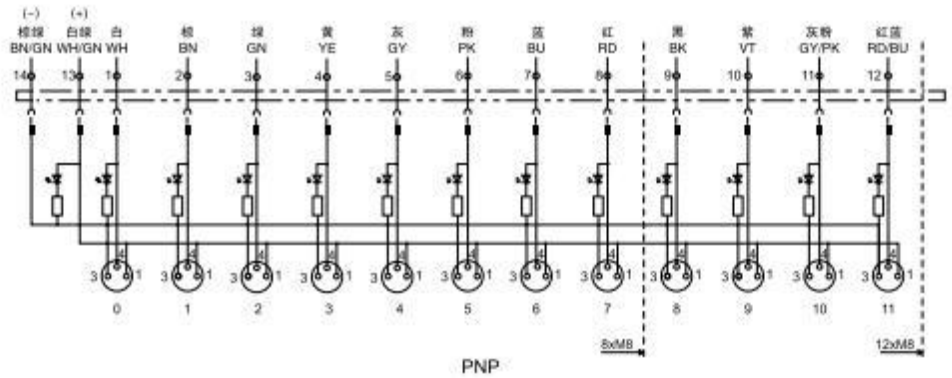

M8 插孔 Female
3-pole



P-05 M8 分配器 – 预铸电缆 DISTRIBUTION SYSTEMS

插头线束
Plug wire harness

4 端口 Way
6 端口 Way

8 端口 Way
10 端口 Way

8 端口 Way

12 端口 Way



1 型号 Form

极数
Suppression

8-pole

8-pole

12-pole

12-pole

10-pole

15-pole

电路图
Circuit diagram

M12 插孔 Female

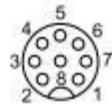

插孔 Female



D-SUB 插孔 Female

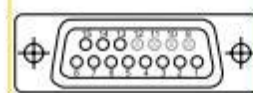

D-SUB 插孔 Female

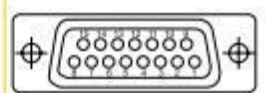

尺寸图 Description

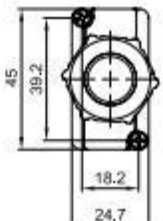
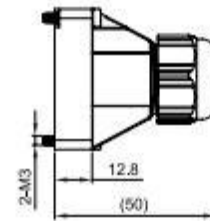
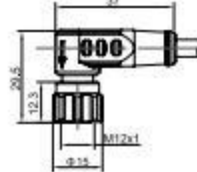
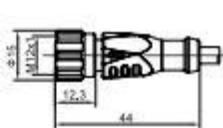

2 电缆类型 Cable type

电缆线经 Wires

灰 GY

灰 GY

灰 GY

灰 GY

PVC

/

$12 \times 0.25 + 2 \times 0.5 \text{mm}^2$

$8 \times 0.25 + 2 \times 0.5 \text{mm}^2$

$12 \times 0.25 + 2 \times 0.5 \text{mm}^2$

PUR

$\times 0.25 + 2 \times 0.5 \text{mm}^2$

$12 \times 0.25 + 2 \times 0.5 \text{mm}^2$

$8 \times 0.25 + 2 \times 0.5 \text{mm}^2$

$12 \times 0.25 + 2 \times 0.5 \text{mm}^2$

3 电缆长度 Cable length

3.0 m

5.0 m

10.0 m

15.0 m

无电缆 Without cable

M12/DB 插入式接线插头
M12 / DB plug-in connector plugs

插头适用电缆直径
Plug for cable diameter

6–8 mm

6–12 mm

P-06 M12 分配器 – 预铸电缆 DISTRIBUTION SYSTEMS

-24V PNP
-24V NPN
-without LED 125 V AC/DC
-单通道
1 signal per port

4 端口 Way



8 端口 Way



1 型号 Form

PNP
NPN
Without LED

电路图

Circuit diagram

引脚定义:
Contact layout

Pin 1: (+)
Pin 3: (-)
Pin 4: (S1)
Pin 4: (PE)

LED 显示: 电源 (绿)
LED indicator: green, power
信号 S1 (黄)
yellow, signal

插孔 Female

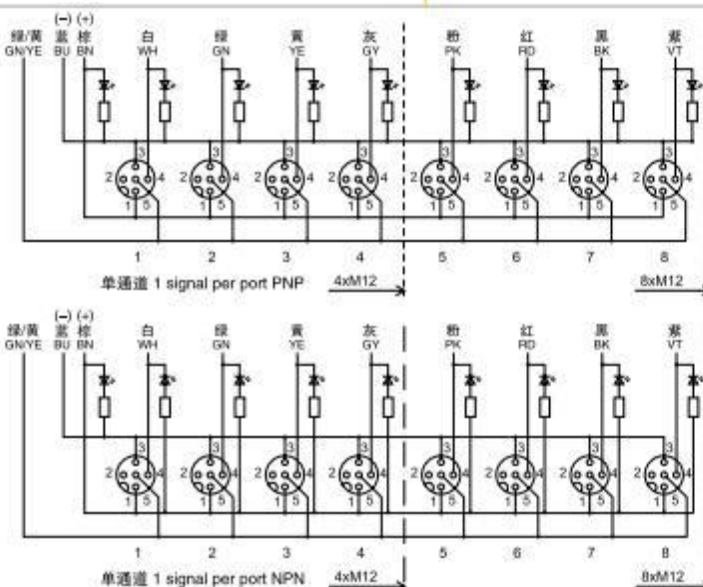

2 电缆类型 Cable type

电缆线经 Wires

	灰 GY	灰 GY
PVC	$4 \times 0.34 + 3 \times 0.75 \text{mm}^2$	$8 \times 0.34 + 3 \times 0.75 \text{mm}^2$
PUR		$8 \times 0.34 + 3 \times 0.75 \text{mm}^2$

3 电缆长度 Cable length

3.0 m

5.0 m

10.0 m

15.0 m

技术参数 Technial data

额定电压 Supply voltage	24 V DC
额定电流 Combined current	4A
防护等级 Protection	IP67
温度范围 Temperature range	-20...+70°C

P-06 M12 分配器 – 预铸电缆 DISTRIBUTION SYSTEMS

- 24V PNP
- 24V NPN
- 无 LED 125 V AC / DC
- 双通道
2 signals per port

4 端口 Way



1 型号 Form

PNP
NPN
Without LED

电路图

Circuit diagram

针脚定义:

Contact layout

Pin 1: (+)

Pin 2: (S2)

Pin 3: (-)

Pin 4: (S1)

Pin 5: (PE)

LED 显示: 电源 (绿)

LED indicator: green, power

信号 S1 (黄)
yellow, signal

信号 S2 (白)
white, signal

插孔 Female

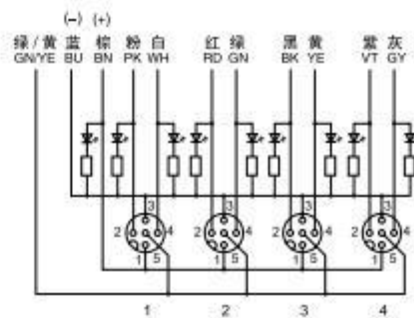

双通道 2 signals per port PNP

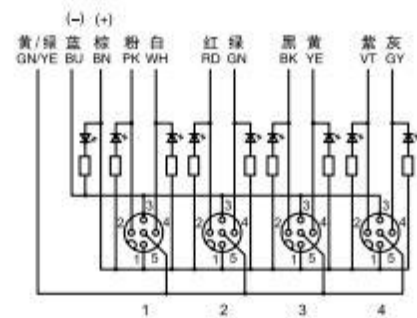

双通道 2 signals per port NPN

2 电缆类型 Cable type

电缆线经 Wires

灰 GY

PVC $8 \times 0.34+3 \times 0.75\text{mm}^2$

PUR $8 \times 0.34+3 \times 0.75\text{mm}^2$

3 电缆长度 Cable length

3.0 m

5.0 m

10.0 m

15.0 m

技术参数 Technial data

额定电压 Supply voltage 24 V DC

额定电流 Combined current 4A

防护等级 Protection IP67

温度范围 Temperature range $-20...+70^{\circ}\text{C}$

P-06 M12 分配器 – 预铸电缆 DISTRIBUTION SYSTEMS

- 24V PNP
- 24V NPN
- 无 LED 125 V AC / DC
- 双通道
2 signals per port

8 端口 Way



1 型号 Form

PNP

NPN

Without LED

电路图

Circuit diagram

引脚定义:

Contact layout

Pin 1: (+)

Pin 2: (S2)

Pin 3: (-)

Pin 4: (S1)

Pin 5: (PE)

LED 显示: 电源 (绿)

LED indicator: green, power

信号 S1 (黄)

yellow, signal

信号 S2 (白)

white, signal

插孔 Female

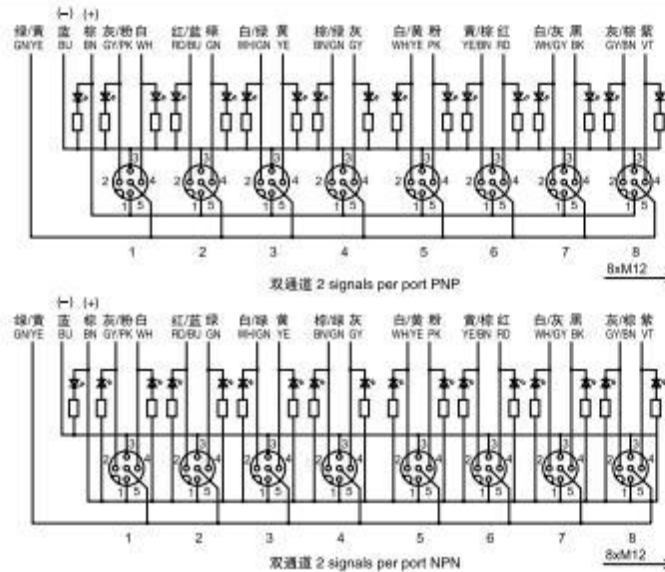

2 电缆类型 Cable type

电缆线经 Wires

灰 GY

PVC $16 \times 0.34 + 3 \times 0.75 \text{mm}^2$ PUR $16 \times 0.34 + 3 \times 0.75 \text{mm}^2$

3 电缆长度 Cable length

3.0 m

5.0 m

10.0 m

15.0 m

技术参数 Technial data

额定电压 Supply voltage 24 V DC

额定电流 Combined current 4A

防护等级 Protection IP67

温度范围 Temperature range $-20...+70^\circ\text{C}$

P-06 M12 分配器 DISTRIBUTION SYSTEMS

M23 预制插头

- With plug connector
- 24V PNP
- 24V NPN
- 无 LED 125 V AC / DC
- 单通道
- 1 signal per port

4 端口 Way



8 端口 Way



1 型号 Form

PNP
NPN
Without LED

电路图 Circuit diagram

针脚定义:
Contact layout

Pin 1: (+)
Pin 3: (-)
Pin 4: (S1)
Pin 5: (PE)

LED 显示: 电源 (绿)
LED indicator: green, power
信号 S1 (黄)
yellow, signal

M12 插孔 Female
4-pole



M23 插针 Male
19-pole

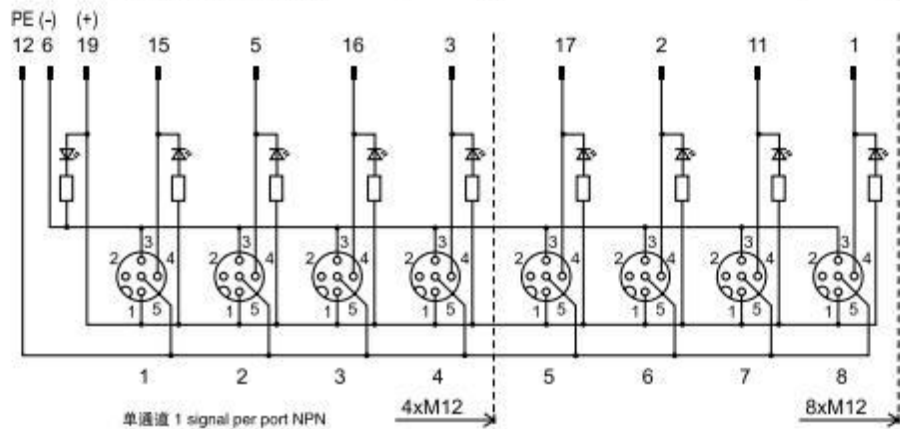
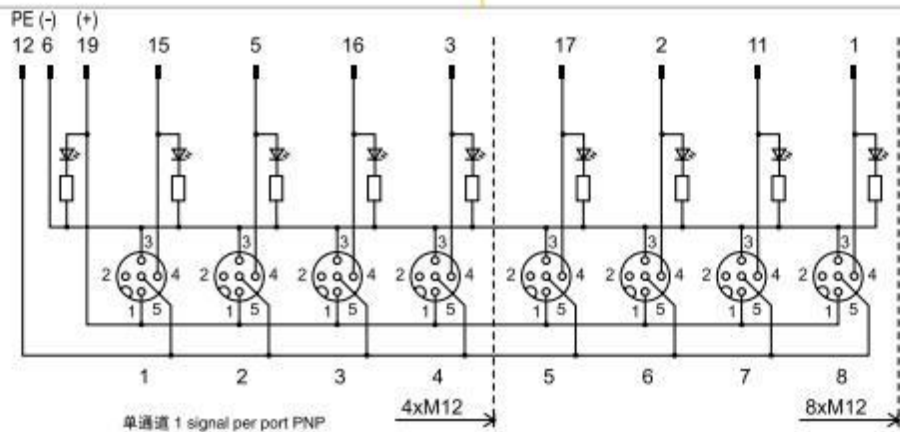
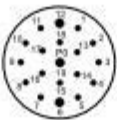

2 技术参数 Technial data

额定电压 Supply voltage	24 V DC
额定电流 Combined current	4A
防护等级 Protection	IP67
温度范围 Temperature range	-20...+70℃

P-06 M12 分配器 DISTRIBUTION SYSTEMS

M23 预制插头

With plug connector

-24V PNP

-24V NPN

- 无 LED 125 V AC / DC

- 双通道

2 signals per port

4 端口 Way



8 端口 Way



1 型号 Form

PNP

NPN

Without LED

电路图

Circuit diagram

引脚定义:

Contact layout

Pin 1: (+)

Pin 2: (S2)

Pin 3: (-)

Pin 4: (S1)

Pin 5: (PE)

LED 显示: 电源 (绿)

LED indicator: green, power

信号 S1 (黄)

yellow, signal

信号 S2 (白)

white, signal

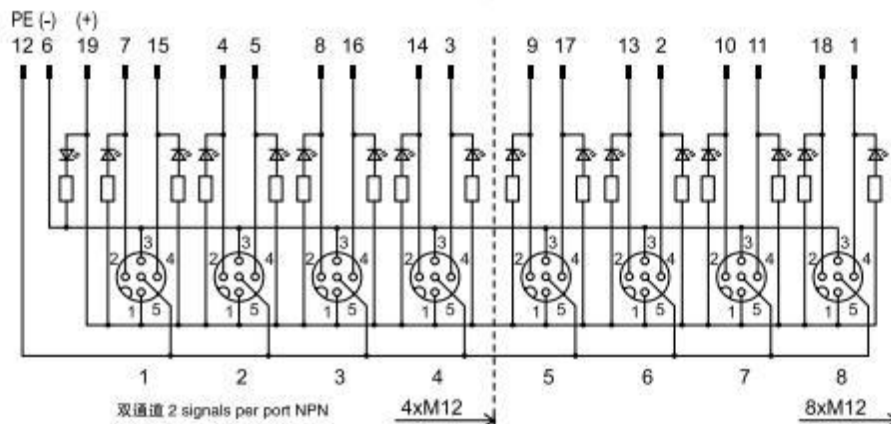
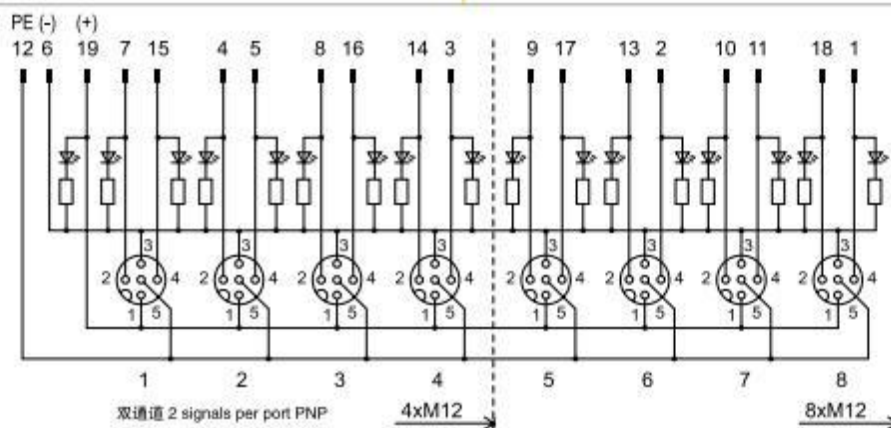
M12 插孔 Female
5-poleM23 插针 Male
19-pole

2 技术参数 Technial data

额定电压 Supply voltage 24 V DC

额定电流 Combined current 4A





防护等级 Protection IP67

温度范围 Temperature range -20...+70°C

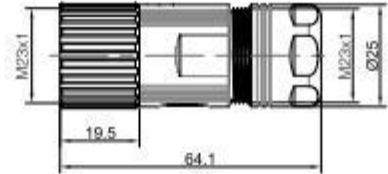
P-06 M12 分配器 DISTRIBUTION SYSTEMS

M23 预制插头
plug connector



电缆长度 (4 端口) Cabel length (4-way)	No. (单通道) No.(for 1 signal per port)	No. (双通道) No.(for 2 signal per port)	No. (双通道) No.(for 2 signal per port)
电缆类型 Cable type	PUR/PVC	PUR/PVC	PUR(UL/CSA) 无卤拖链电缆 halogen free
3.0 m			
5.0 m			
10.0m			
15.0m			
线径 Wire diameter	4 × 0.34/3 × 0.75mm ²	8 × 0.34/3 × 0.75mm ²	8 × 0.5/3 × 1.0mm ²
电缆 Cable NO.			
电缆长度 (8 端口) Cabel length (8-way)	No. (单通道) No.(for 1 signal per port)	No. (双通道) No.(for 2 signal per port)	No. (双通道) No.(for 2 signal per port)
电缆类型 Cable type	PUR/PVC	PUR/PVC	PUR(UL/CSA) 无卤拖链电缆 halogen free
3.0 m			
5.0 m			
10.0m			
15.0m			
线径 Wire diameter	8 × 0.34/3 × 0.75 mm ²	16 × 0.34/3 × 0.75mm ²	16 × 0.5/3 × 1.0mm ²
电缆 Cable NO.			
电路图 Circuit diagram	 (4 端口单通道) 4-way for 1 signal per port	 (4 端口双通道) 4-way for 2 signal per port	 (8 端口单通道) 8-way for 1 signal per port
M23 插孔 Female 19-pole			 (8 端口双通道) 8-way for 2 signal per port
无电缆 Without cable M12/DB 插入式接线端口 M12 / DB plug-in connection ports	No. (4 端口单通道)		No. (4 端口双通道)
无电缆 Without cable M12/DB 插入式接线端口 M12 / DB plug-in connection ports	No. (8 端口单通道)		No. (8 端口双通道)
插头适用电缆直径 Plug for cable diameter	7-14mm		

P-06 M12 分配器 M23 预铸线 ROUND PLUG CONNECTOR

预铸线 pre-cast connector
19-pole
单通道
1 signal per port

插孔 Female
直出 Straight

4 端口 Way



插孔 Female
直出 Straight

8 端口 Way



1 型号 Form

插孔 Female
90°

4 端口 Way



插孔 Female
90°

8 端口 Way



型号 Form

极数

Suppression

7-pole

11-pole

电路图

Circuit diagram



针脚排序

Contact layout

M23 插孔 Female
7-poleM23 插孔 Female
11-pole

2 电缆类型 Cable type

护套颜色 Jacket color

线径 Wire

PVC 4 x 0.34 / 3 x 0.75mm²PUR 0.5/01.0mm²

灰 GY

4 x 0.34+3 x 0.75mm²

灰 GY

8 x 0.34+3 x 0.75mm²8 x 0.34+3 x 0.75mm²

3 电缆长度 Cable length

5.0 m

10.0 m

15.0 m

P-06 M12 分配器 M23 预铸线 ROUND PLUG CONNECTOR

预铸线 pre-cast connector
19-pole
双通道
2 signals per port

插孔 Female
直出 Straight

4 端口 Way

插孔 Female
直出 Straight

8 端口 Way



1 型号 Form No.

插孔 Female
90°

4 端口 Way

插孔 Female
90°

8 端口 Way



型号 Form No.

极数
Suppression

11-pole

19-pole

电路图
Circuit diagram



针脚排序
Contact layout

M23 插孔 Female
11-pole



M23 插孔 Female
19-pole

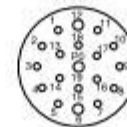

2 电缆类型 Cable type

线径 Wire
PVC 0.34 / 0.75mm²
PUR 0.5/0.1.0mm²

护套颜色 Jacket color

灰 GY

8 × 0.34+3 × 0.75mm²
8 × 0.34+3 × 0.75mm²

灰 GY

16 × 0.34+3 × 0.75mm²
16 × 0.34+3 × 0.75mm²

3 电缆长度 Cable length

5.0 m

10.0 m

15.0 m

P-06 M12 分配器 DISTRIBUTION SYSTEMS

PCB 端子
PCB terminals
-24V PNP
-24V NPN
- 无 LED 125 V AC / DC
- 单通道
1 signal per port

4 端口 Way

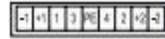

8 端口 Way

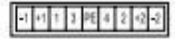

1 型号 Form

PNP
NPN
Without LED



1 型号 Form

螺钉压接插头 Spring clamp plug-in terminals

PNP
NPN
Without LED

电路图
Circuit diagram

引脚定义:
Contact layout

Pin 1: (+)
Pin 3: (-)
Pin 4: (N/O)/(S1)
Pin 5: (PE)

LED 显示: 电源 (绿)
LED indicator: green, power
信号 S1 (黄)
yellow, signal

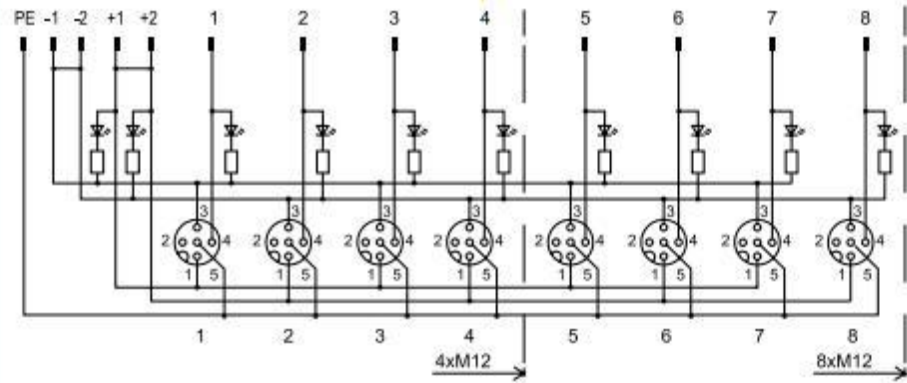

单通道 1 signal per port PNP

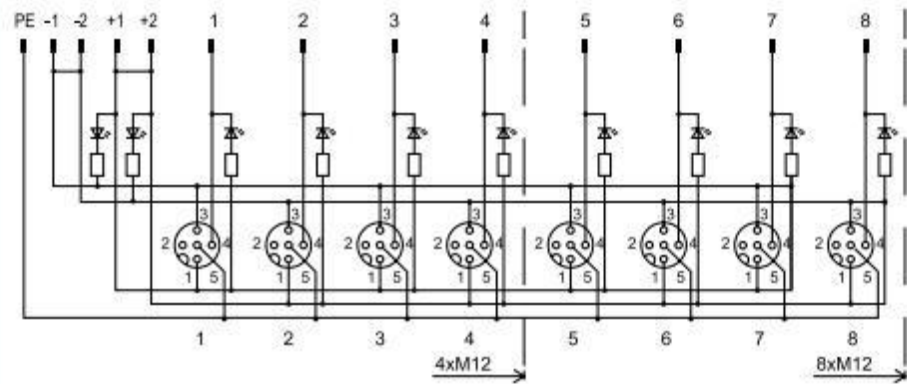

单通道 1 signal per port NPN

插孔 Female



P-06 M12 分配器 DISTRIBUTION SYSTEMS

PCB 端子
PCB terminals
-24V PNP
-24V NPN
- 无 LED 125 V AC / DC
- 双通道
2 signals per port

4 端口 Way



8 端口 Way

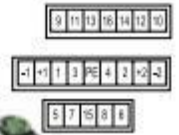

1 型号 / Form

PNP
NPN
Without LED



1 型号 Form

螺钉压接插头 Spring clamp plug-in terminals

PNP
NPN
Without LED

电路图 Circuit diagram

针脚定义:
Contact layout

Pin 1: (+)
Pin 2: (N/C)/(S2)
Pin 3: (-)
Pin 4: (N/O)/(S1)
Pin 5: (PE)

LED 显示: 电源 (绿)
LED indicator: green, power
信号 S1 (黄)
yellow, signal
信号 S2 (白)
white, signal

插孔 Female

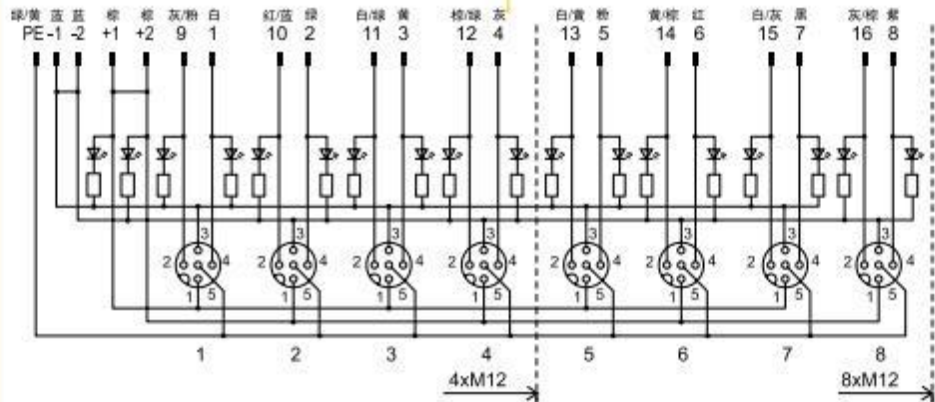

双通道 2 signals per port PNP

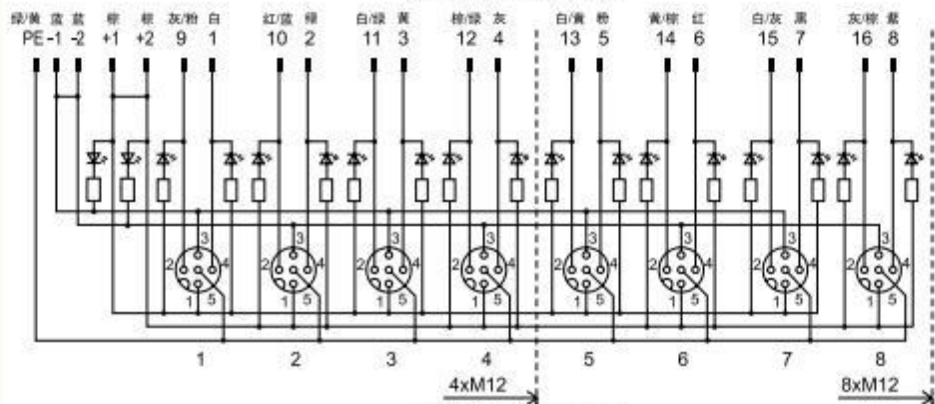

双通道 2 signals per port NPN

P-06 M12 分配器 DISTRIBUTION SYSTEMS

现场接线插头
Field-wireable connection cap

预制线螺丝压接线端子
Screw plug-in terminals

带线插头 Pre-wired with



4 端口 Way	No. (单通道 for 1 signal per port)	No. (双通道 for 2 signal per port)	No. (双通道 for 2 signal per port)
电缆类型 Cable type	PUR/PVC	PUR/PVC	PUR(UL/CSA) 无卤拖链电缆 halogen free
3.0 m			
5.0 m			
10.0m			
15.0m			
线径 Wire diameter	$4 \times 0.34+3 \times 0.75\text{mm}^2$	$8 \times 0.34+3 \times 0.75\text{mm}^2$	$8 \times 0.5+3 \times 1.0\text{mm}^2$
电缆 Cable NO.			
8 端口 Way	No. (单通道 for 1 signal per port)	No. (双通道 for 2 signal per port)	No. (双通道 for 2 signal per port)
电缆类型 Cable type	PUR/PVC	PUR/PVC	PUR(UL/CSA) 无卤拖链电缆 halogen free
3.0 m			
5.0 m			
10.0m			
15.0m			
线径 Wire diameter	$8 \times 0.34+3 \times 0.75\text{mm}^2$	$16 \times 0.34+3 \times 0.75\text{mm}^2$	$16 \times 0.5+3 \times 1.0\text{mm}^2$
电缆 Cable NO.			

无电缆 Without cable



4 端口 Way	No. (单通道 for 1 signal per port)	No. (双通道 for 2 signal per port)
螺丝插入式接线端口 With screw plug-in terminals		
插头适用电缆直径 Plug for cable diameter	8.5...14.0mm	
8 端口 Way	No. (单通道 for 1 signal per port)	No. (双通道 for 2 signal per port)
螺丝插入式接线端口 With screw plug-in terminals		
插头适用电缆直径 Plug for cable diameter	8.5...14.0mm	

P-06 M12 分配器 DISTRIBUTION SYSTEMS

双电源 Dual power supply
 现场接线 Field wiring
 带插座 Screw plug-in or
 螺钉压接插头 Spring clamp plug-in terminals

4 端口 Way



8 端口 Way

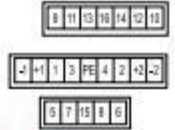

1 型号 Form

螺钉压接插头 spring clamp plug-in terminals

PNP

NPN

电路图

Circuit diagram

针脚定义:

Contact layout

Pin 1: (+)

Pin 2: (S2)

Pin 3: (-)

Pin 4: (S1)

Pin 5: (PE)

LED 显示: 电源 1(绿)
 LED indicator: green, power 1

电源 2(红)
 red, power 2

信号 S1(黄)
 yellow, signal

信号 S2(白)
 white, signal

插孔 Female

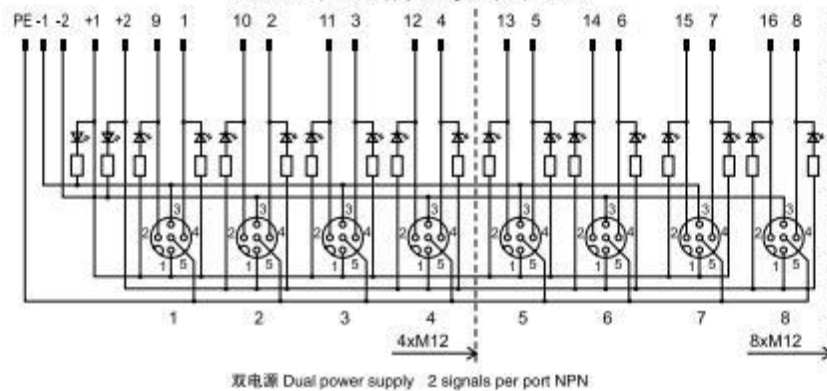
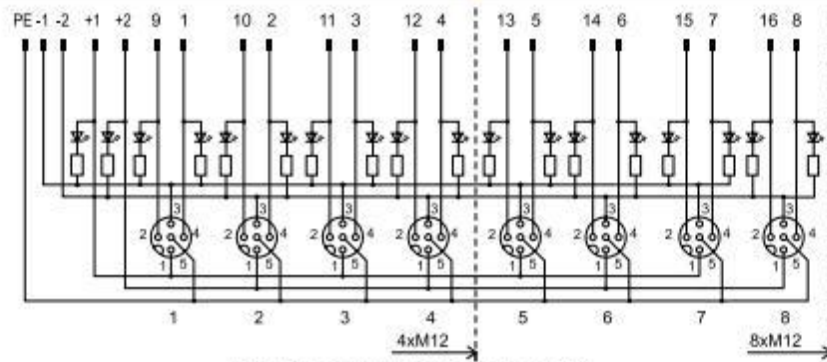

2 技术参数 Technial data

额定电压 Supply voltage	24 V DC
额定电流 Combined current	4A
防护等级 Protection	IP67
温度范围 Temperature range	-20...+70℃
插头适用电缆直径 Plug for cable diameter	8.5...14.0mm

P-07 7/8" 分线盒 JUNCTION BOX

Power Junction Box
IP67 电源分线盒

4 端口 Way



8 端口 Way



1 型号 Form No.

极数
Suppression

4-pole

4-pole

针脚定义:
Contact layout

插针 Male 4-pole

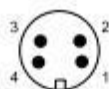

插孔 Female 4-pole

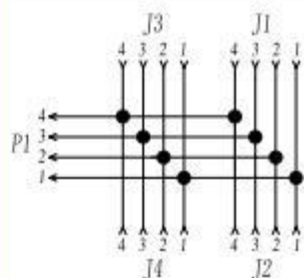

4 端口电路图

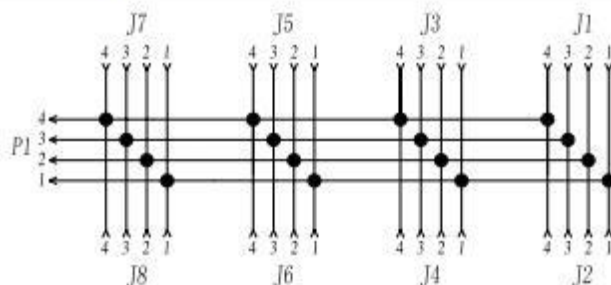

8 端口电路图

尺寸图 Description

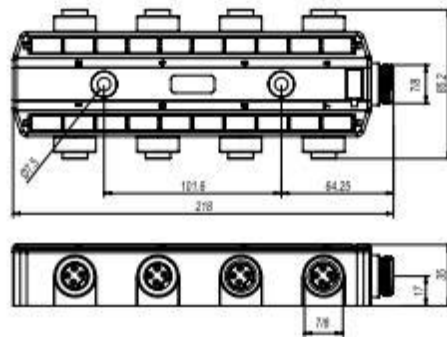
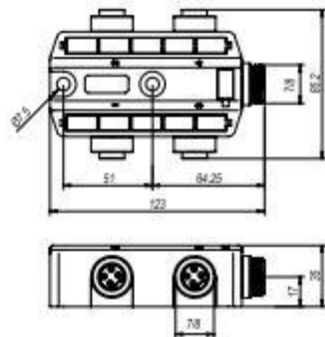

2 技术参数 Technial data

额定电压 Supply voltage	600 V AC / DC
额定电流 Combined current	8A
防护等级 Protection	IP67
温度范围 Temperature range	0°C ...+60°C
材质 Insert	TPU
壳体 Housing	聚酯 Pet (Polyester)
插座外壳 Receptacle Housing	铜镍镍 Cu-Ni plated brass

P-07 附件 ACCESSORIES

电缆标识附件 Labeling accessories	
	M8 分配器端口保护盖 Blind plug M12 分配器端口保护盖 Blind plug
	M12 分配器标识板 Label plates 2 plates = 10 pieces
	M8 连接器安装扳手
	M12 连接器现场接线安装扳手
	M8, 3-pole
	M8, 3-pole, 配合 M8 连接器安装扳手使用
	M12, 4-pole, 电缆出线范围 Wire diameter 4-6mm M12, 4-pole, 电缆出线范围 Wire diameter 4-6mm
	M12, 5-pole, 电缆出线范围 Wire diameter 4-6mm M12, 5-pole, 电缆出线范围 Wire diameter 6-8mm
	M12, 4-pole, 双孔连接器, 电缆出线范围 Wire diameter 5.2-3.5mm
	M12-2M12, Y 型连接器 Y type connector
	M12-2M8, Y 型连接器 Y type connector
	SHD 8 4 连接器固定器, 适用于 M8 预铸线, M4 螺丝
	SHD 12 4 连接器固定器, 适用于 M8 现场接线与 M12 预铸线, M4 螺丝



线槽 | 智能照明灯 | 冷压端子 | 端子台 | 导轨 | 管件接头 | 地零排 | 绝缘母线夹 | 拖链 | 结束带
 编织网管 | 热缩管 | Pu气管 | 扣件保护 | 标识类 | 航空插头 | 重载连接器 | 工具系列 | 风机系列

Wenbuluo

江苏稳不落配线器材有限公司
 Wenbuluo Electrical Co., Ltd

☎ 0512-36602880

🌐 www.wenbuluo.com www.wenbuluo.cn

📍 江苏省苏州市昆山市开发区熊庄路25号